

ITALY

MIDDLE EAST - ASIA - AFRICA

+39 0331 960474



+971 4 265 2346 (showroom)
+971 4 269 1319 (main office)

+39 0331 960166



+971 4 265 2275

info@teknaline.com



info@gianni-gelato.com

www.teknaline.com



www.teknaline.com

Tekna s.r.l.
via Verdi 35
21021 Angera (VA)



AJD Building, 5th Street, Showroom 4-8
Umm Ramool (Opp Bin Dhaheer Motors Co.)
P.O. Box 27886 - Dubai (U.A.E.)

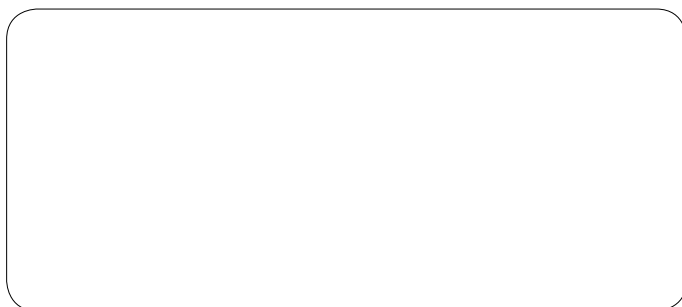

UNI EN ISO 9001 Cert. n.:9105.TKNA



MEATLINE



CHEESELINE



WINELINE



PASTRYLINE



ICECREAMLIN



2022

STANDARD SERIES

STORIA DI UN GRANDE AMORE

#finoallafine



STORIA

STORY

Tekna nasce nel 1990 da un'idea e dall'esperienza dell'Ing. Luigi Paracchini, il quale dopo aver lavorato per molti anni in una grossa compagnia a livello mondiale nel settore della refrigerazione, decide di mettere le proprie competenze sul campo creando una linea di prodotti rivolti al settore della gelateria e pasticceria.

Sempre attenta alle esigenze del mercato ed evolvendosi di conseguenza, ora Tekna è una realtà che esporta nei 5 continenti e che offre una gamma completa di soluzioni che spaziano dal piccolo punto vendita, al laboratorio, alla grande distribuzione.

Tekna was born in 1990 from an idea of Engineer Luigi Paracchini. After years of experience in a multinational company in the field of refrigeration, he decided to establish his own company creating his own line of products in the field of ice cream and bakery.

Always attentive to the needs of the market and updating as a result, Tekna is present in 5 continents and offers a full range of solutions from small shops, laboratories to the large-scale distribution.

INNOVAZIONE

INNOVATION

Da sempre Tekna è attenta all'evoluzione del mercato e della tecnologia, introducendo già negli anni '90, tra i primi nel settore: la tecnologia no-frost, le vetrine isolate a gas inerte e basso emissive, gli sbrinatori a gas caldo.

Il mercato in continua evoluzione chiede alle aziende sempre più attenzione alle innovazioni. Tekna raccoglie la sfida implementando nei propri prodotti tutti gli accorgimenti tecnologici che nel tempo si sono presentati. Nuovi materiali, nuovi gas, nuovi sistemi di espansione, nuovi controlli e gestione della temperatura, materiali e finiture, presentazione del prodotto conservato; sono solo alcuni degli aspetti con cui lo staff Tekna si confronta quotidianamente.

Tekna has always had a focus on the evolution of the market and technology, being one of the first to introduce in the '90s: the no-frost system of refrigeration, isolated glasses with inert gas and low-e glasses, de-frost with the use of hot gas. The market continuously pays attention to innovation. Tekna satisfies it using new materials, new gases, new expansion system, new temperature controllers and finishing; these are few aspects of the innovation that Tekna faces every day.

CERTIFICATI

MARKS































Tekna da molti anni è in possesso del certificato gestione qualità ISO 9001.

Al giorno d'oggi uno degli aspetti più importanti da considerare è la conformità alle regole nazionali ed internazionali. Quasi tutti i mercati sono regolati da norme specifiche in materia di sicurezza elettrica e ambientale. Tekna investe molte risorse nell'ottemperare alle normative, questo le ha permesso di ottenere nel tempo la certificazione dei propri prodotti presso i più autorevoli enti certificatori ottenendo i marchi qualità di molti paesi esteri.

Since many years Tekna is certified for quality ISO 9001.

Nowadays one of the most important aspects to consider is the conformity to the national and international laws. Almost all markets are ruled by specific laws for electrical and environment safety. Tekna invests many resources to comply with the existing regulations, this has enabled it to obtain the certification of its products through the most authoritative international certification bodies.

INDICE

		PAG 5
		PAG 36
		PAG 41
		PAG 47
		PAG 83
		PAG 87
		PAG 91
		PAG 97
		PAG 99
		PAG 105
		PAG 111
		PAG 115
		PAG 119
		PAG 135
		PAG 137
		PAG 143

P	statico positivo	temperatura	+2 / +10 °C	P
P	static high temperature	temperature	+2 / +10 °C	
NT	statico negativo	temperatura	-15 / -25 °C	NT
NT	static low temperature	temperature	-15 / -25 °C	
NP	statico temperatura combinata	temperatura	-15 / -25 °C +2 / +10 °C	NP
NP	static combined temperature	temperature	-15 / -25 °C +2 / +10 °C	
NFP	ventilato positivo	temperatura	-5 / +10 °C	NFP
NFP	no-frost high temperature	temperature	-5 / +10 °C	
NFN	ventilato negativo	temperatura	+5 / -25 °C	NFN
NFN	no-frost low temperature	temperature	+5 / -25 °C	
CB	ventilato combinato	temperatura	+5 / -25 °C -5 / +10 °C	CB
CB	no-frost combined temperature	temperature	+5 / -25 °C -5 / +10 °C	
NFA	congelatore rapido 1 motore	temperatura	-18 / -40 °C	NFA
NFA	shock freezer 1 engine	temperature	-18 / -40 °C	
NFNA	congelatore rapido 2 motori	temperatura	-18 / -40 °C	NFNA
NFNA	shock freezer 2 engines	temperature	-18 / -40 °C	
FL	fermalievitazione	temperatura	+30 / -5 °C	FL
FL	stop rising	temperature	+30 / -5 °C	
CBA	ventilato negativo - congelatore rapido	temperatura	+5 / -25 °C -18 / -40 °C	CBA
CBA	no-frost low temperature - shock freezer	temperature	+5 / -25 °C -18 / -40 °C	



STATIC

Circolazione naturale dell'aria nella cella:
 - sbrinamento manuale per temperatura negativa
 - sbrinamento automatico per temperatura positiva

*Natural circulation of the air in the cell:
 - manual defrosting for negative temperature
 - automatic defrosting for positive temperature*



NO-FROST

Circolazione dell'aria sulle pareti interne con l'ausilio di dispositivi meccanici. Temperatura uniforme in tutta la cella. Sbrinamento automatico a gas caldo e a controllo elettronico.

Air Circulation on the inside walls with the aid of mechanical devices. Temperature uniform in the whole cell. Automatic defrosting with warm gas and with electronic control.

DIMENSIONI ESTERNE VETRINA
EXTERNAL DIMENSIONS

MODELLO
MODELS

670 X 640 X 1910 (1220 TOP) mm

4100

TIPO DI REFRIGERAZIONE REFRIGERATION TYPE	NUMERO COMPRESSORI ENGINE NUMBER	VOLUME IN LITRI VOL. LITER	PREZZO PRICE
RANGE TEMPERATURA TEMPERATURE RANGE	CONSUMO EL. COMPRESSORE CONSUMPTION ENGINE	PESO NETTO - LORDO NET - GROSS WEIGHT	

FOTO PRODOTTO
PRODUCTS IMAGE



*modelli statici 1880 mm
static model 1880 mm

NOTE

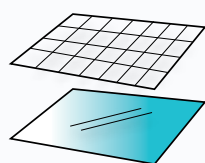
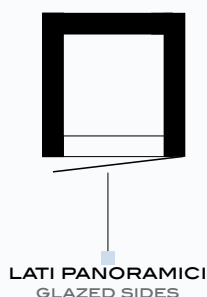

ACCESSORI E OPZIONI
ACCESSORIES AND OPTIONALS

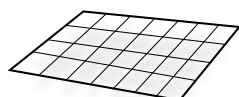

Assetto interno con ripiani a griglia e supporti
Inner settings: grid shelves with supports

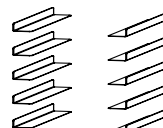

Assetto interno supporti porta teglie
cm. 60 x 40
Inner settings: guides for trays 60x40 cm

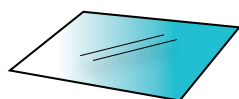

Assetto interno con ripiani in vetro e supporti
Inner settings: glass shelves with supports



Assetto interno con carosello per ripiani R26 e R32
Inner settings: 26 rotating wedges for models R26 or R32.

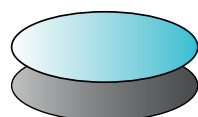

Assetto interno rotante con ripiani in vetro e specchio circolari per rotanti
Inner settings: rotating shelves

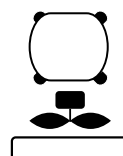

Gruppo frigorifero a distanza
(necessita di informazioni da parte del cliente per individuarne la potenza.)
Remote compressor (with client's requirements)

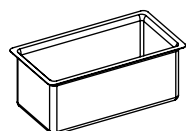

Assetto interno con ripiani a griglia per vasche gelato 5 e 10 Kg.
Inner settings: grid shelves for ice cream pans 5kg and 10kg.



Regolatore velocità ventole, permette di agire sulla velocità delle ventole evaporatore.
Fan speed controller



TEKNA
SINCE 1990

Dopo una lunga esperienza nel campo della refrigerazione commerciale, nasce TEKNA S.r.l. Il suo fondatore, l'Ingegnere Luigi Paracchini, con l'aiuto dei suoi collaboratori crea la prima sede della società a Sesto Calende, dove nascono i primi prodotti TEKNA:

le vetrine frigorifere destinate alle gelaterie, pasticcerie, pizzerie ecc.

Nel mercato italiano ed europeo TEKNA organizza un organico ben definito per zone, che affida a rivenditori fidati: in breve tempo l'azienda è presente su tutto il territorio.

Established in 1990, by his founder, Engineer Luigi Paracchini, TEKNA S.R.L.

had his first head quarter in Sesto Calende (Italy), where he starts the production of professional showcases and refrigerators.

Since the beginning our main markets has been Italy and Europe having trusted retailers in all the Countries. Shortly the brand TEKNA became well known in the whole Europe.

Together with his two sons, Engineer Paracchini increased TEKNA's range of products, manufacturing laboratory cabinets, shock freezer,

Con l'aiuto dei suoi due figli, l'Ing. Paracchini amplia la gamma dei prodotti TEKNA, inserendo nella produzione gli armadi da laboratorio, gli abbattitori di temperatura per gelateria e pasticceria e infine i fermalievitazione.

La crescita di Tekna verso la globalizzazione ha stimolato il desiderio di produrre prodotti certificati e sicuri.

Dal 1998 TEKNA è certificata a livello internazionale. Questo ha permesso a TEKNA di sviluppare una rete di rivenditori esclusivi che garantisce la distribuzione ed il continuo supporto al cliente finale.

retarder provers and under-counters for any professional use.

The growth of TEKNA towards the globalization has stimulated the wish of manufacturing safer and certified products. Since 1998 Tekna is certified at International levels.

This allowed Tekna to expand rapidly all over the World, developing a sales network of exclusive dealerships which have guaranteed widespread distribution and continuous, prompt support for end users.

Today Tekna reaches an annual production of 10.000 cabinets and

Oggi TEKNA può vantare una produzione annua di 10.000 macchine ed ha la capacità di fornire un'assistenza tecnica costante al cliente.

È suo inoltre il primato nella fornitura di prodotti su misura per soddisfare qualsiasi esigenza.

TEKNA ha organizzato un team che studia i bisogni dei clienti trovando soluzioni personalizzate in base alle richieste specifiche, cercando materiali innovativi pianificando nuove soluzioni per nuovi prodotti nel mondo della refrigerazione. I prodotti possono essere personalizzati in base alle richieste dei clienti.

provides continued technical support to our customers.

Our priority is to provide customized products to meet all their needs.

Tekna has organized a team that studies the needs of the clients, finds "custom made" solutions for specific requests, seeks innovative materials, plans new solutions for new products in the refrigeration business. In fact, all the products can be customized with the exact requirements that the customer would like to have on the cabinets.

ConneX
ASSIST



INNOVAZIONE, DESIGN & CONNETTIVITA' *INNOVATION, DESIGN & CONNECTIVITY*

Il controllo della tua vetrina refrigerata a portata di smartphone.
Control your refrigerated showcase just a click away on your smartphone.



INNOVAZIONE, DESIGN & CONNETTIVITA'

Controllore di temperatura per unità statiche e ventilate a temperatura positiva e negativa con connettività integrata WiFi, Bluetooth e Data Logger.

Connettibile simultaneamente al Cloud ATEX e all'App locale ConneX

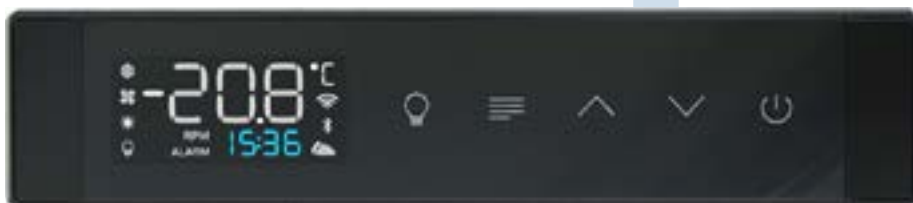

- TASTI CAPACITIVI
- DOPPIO DISPLAY con 7-SEGMENTI BICOLOR
- DATA LOGGER
- APP CONNEX



ConneX

FUNZIONI DEDICATE

WINERY

- Letture della zona vini bianchi e vini rossi
- Impostazione dell'ora di on/off della luce vano
- Accensione e spegnimento della ventola di ricircolo
- Funzioni gestite anche dall'Applicazione ConneX

PASTICCERIA/GELATERIA

- Imposta la configurazione gelateria/pasticceria
- Sbrinamento con avvio al setpoint
- Tasti up/dw per un attuatore ausiliario
- Impostazione dell'ora di on/off della luce vano
- Display remoto connettibile su linea CANBUS
- Funzioni gestite anche dall'Applicazione ConneX

PRALINERIA

- Funzione CLIMA per il controllo temp./umidità
- Letture simultanea della temperatura e umidità
- Grafico delle variabili tramite App. ConneX

MATURAZIONE CARNE ??

- Azione Heating per piani caldi
- Sbrinamento per rilevazione di ghiaccio
- Sbrinamento a orario
- Report HACCP settimanale tramite App o Cloud



CARATTERISTICHE

Flex

- Box in ABS - Dima L150xW31mm
- Montaggio a incasso o retropannello
- Alimentazione 110/230Vac - 50/60Hz
- Memoria Flash da 2Mb per Data Logger
- Orologio RTC con supercap di mantenimento
- N°3 sonde NTC [-49.9, +99.9]°C Ris. 0.1°C
- N°2 ingressi digitali
- N°5 Relè: 30A-8A SPDT-5A-5A-5A
- N°2 porte CanBUS
- Moduli Wi-Fi e BLE integrati

VETRINA REFRIGERATA
prezzo netto € 330,00 cad. + iva

VETRINA PER MATURAZIONE CARNE
net price € 600,00 cad. + iva

INNOVATION, DESIGN & CONNECTIVITY

Temperature controller for static and ventilated refrigerated units at positive and negative temperatures with built-in Wi-fi, Bluetooth and Data Logger connectivity.
Simultaneously connected to the ATEX Cloud and the local Connex App.

- CAPACITIVE KEYS
- DUAL DISPLAY
- 7-SEGMENTS BICOLOUR
- DATA LOGGER
- CONNEX APP



DEDICATED FUNCTIONS

CARATTERISTICHE

Flex

- ABS box – template L 150 x W 31 mm
- Recessed or back panel assembly
- Power supply 110/230 Vac – 50/60 Hz
- 2 mb flash memory for Data Logger
- RTC clock with supercap maintenance
- No 3 NTC probes (-49.9, +99.9)°C Ris. 0.1 °C
- No 2 digital inputs
- No 5 relays:30A-8A SPDT-5A-5A-5A
- No 2 CanBUS ports
- Integrated Wi-Fi and BLE modules

WINERY

- White and red wines monitoring
- Chamber lights on/off time setting
- Recirculation fan on/off switch
- Managing functions from Connex App

PASTRY / ICE-CREAM

- Ice cream/pastry configuration setting
- Defrosting at set point start
- Up/Dw keys selection
- Chamber lights on/off time setting
- Remote display connectable through CANBUS cable
- Managing functions from Connex App

PRALINES

- CLIMA function to control temperature and humidity
- Simultaneous temperature and humidity monitoring
- Variable graph through Connex App

MEAT DRY AGING

- Azione Heating per piani caldi
- Sbrinamento per rilevazione di ghiaccio
- Sbrinamento a orario
- Report HACCP settimanale tramite App o Cloud



REFRIGERATED SHOWCASES
net price € 330,00 cad. + iva

DRY AGE SHOWCASES
net price € 600,00 cad. + iva

APPLICAZIONE CONNEX

Applicazione per la connettività locale con i termostati della serie FLEX. Permette il completo controllo del dispositivo, la programmazione dei parametri letti da file o da QR Code; traccia i grafici delle variabili monitorate e presenta la lista degli eventi di difformità.

MENU

- GRAFICI
- LISTA EVENTI
- INFO DISPOSITIVO
- CONFIGURATORE DISPOSITIVO
- IMPOSTAZIONE PARAMETRI
- IMPOSTAZIONE LIMITI
- ESTRAZIONE DATI (SHARE)
- LETTORE QR PARAMETRI
- IMPOSTAZIONI DI RETE WIRELESS
- TEMPERATURA VANO IMPOSTA SETPOINT

SERVIZI

- MAIL DI ALERT
- MAIL DI CHIUSURA ALERT
- RICEZIONE SETTIMANALE TRAMITE
- MAIL DEL REPORT GRAFICO IN PDF





E V O ■ L I N E



EVOLINE

Presentazione

NEL 2018 nasce Evo, il nuovo concept di Tekna, rivolto al futuro ed all'evoluzione del brand.

Da sempre all'avanguardia in fatto di tecnologia e di design, Tekna propone un rinnovamento, rispettando il familiar feeling delle linee iconiche che la caratterizzano ed apportando modifiche strutturali ed estetiche volte al miglioramento ed all'evoluzione del prodotto esistente.

Evo, disponibile in dimensioni standard predefinite, con infinite varianti colore, è adattabile a qualsiasi esigenza ed inseribile in qualsiasi contesto specifico.

Gestione degli allarmi acustici e visivi, Display incorporato nel vetro con tecnologia Sensitive touch, Maniglia ad incasso nel profilo della porta.

Eleganza ed Innovazione la contraddistinguono.

Per l'Azienda infatti questo non è un punto di arrivo perchè "Evolversi non è importante ma è l'unica cosa che conta" Michele Paracchini.

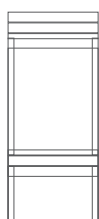

Glassy line



Lexus line



Evo line



Presentation

Evo was born, the new Tekna concept, facing the future and the evolution of the brand.

Always at the forefront of technology and design, Tekna proposes a renewal, respecting the familiar feeling of the iconic lines that characterize it and making structural and aesthetic changes aimed at improving and evolving the existing product.

Evo is available standard dimensions sizes, with any color variations, is adaptable to any need and can be inserted in specific context.

Management of audible and visual alarms, display incorporated in the glass with Sensitive touch technology, recess handle in the door profile.

It is the perfect combination of professionalism, quality and elegance.

“Evolving is the most important thing”

Michele Paracchini.

GAS R290

Grazie al suo basso impatto ambientale ed alle eccellenti proprietà termodinamiche, l'uso dell'R290 continua ad aumentare.

Con indubbi benefici per la salute dell'uomo e l'ambiente, i refrigeranti alternativi sarebbero determinanti nella diminuzione delle emissioni di anidride carbonica nell'atmosfera e nel contenimento della temperatura globale del pianeta.

La linea EVO accoglie a 360° le nuove tendenze dello stile, nelle performance, nell'efficienza e nel rispetto dell'ambiente.

Thanks to its low environmental impact and excellent thermodynamic properties, the use of the gas R290 continues to increase.

With undoubted benefits for human health and the environment, alternative refrigerants are crucial in reducing carbon emissions into the atmosphere and the global temperature.

The EVO line welcomes all the new trends in style, performance, efficiency and respect for the environment.







■ Termostato touch, incorporato nel vetro, con Energy Saving e funzionalità HCCP.

Nuovo design più moderno ed elegante, minimalista ed efficiente.

Touch screen controller, embedded in the glass, with Energy Saving and HCCP functions.

It has a new modern and elegant design, minimalist and efficient



■ Illuminazione a led e interno inox a specchio.

LED lighting and mirrored stainless steel interior.



Maniglia incassata per garantire una maggiore ergonomia di utilizzo.

Supporti vetro con guarnizione anticaduta.

Recessed handle to ensure greater use.

Glass supports with anti-fall seal.



Copertura vano motore realizzata interamente in alluminio e microforata, per la dissipazione il calore. EVO, la nuova vetrina refrigerata di TEKNA, è ad impatto zero grazie all'utilizzo di soli materiali riciclabili.

Engine compartment cover made entirely of aluminum and micro-perforated for heat dissipation.

EVO, Tekna's new refrigerated display case, has zero impact thanks to the use of only recyclable materials.

ACCESSORI

OPTIONS

	CHO Versione cioccolato (+15/+18 °C; umidità: 35/55%) Chocolate version (+15/+18 °C; humidity: 35/55%)		700,00 €
	IL Imballo in legno Packing wooden crate	M 0,75 M 1 M 1,5	440,00 € 590,00 € 740,00 €
	GR Motore remoto Remote power unit		680,00 €
	TR Versione tropicalizzata Tropical version		540,00 €
	HO Gruppo condensazione ad acqua Water condensation system		1.280,00 €
	RGB Vano motore retroilluminato Lighting bottom part		490,00 €
	VE Valvola espansione Expansion valve		410,00 €
	VS Voltaggio speciale Special voltage	115V - 60Hz 220V - 60Hz	530,00 € 300,00 €
	AC Allarme temperatura condensatore Condenser temperature alarm		370,00 €
	SIDE Laterale serigrafato Screen printed side		470,00 €
	GLASS LEDGES (X6) Kit ripiani in vetro per vetrina statica (NT) Kit glass ledges for static showcase (NT)		inclusi included





EVO

EVO 460 460 X 640 X 1930 mm

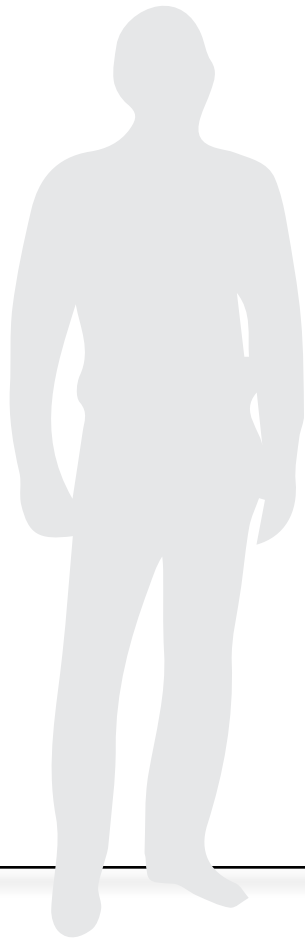

FINITURA BIANCA
WHITE FINISHING



FINITURA BRONZO
BRONZE FINISHING



FINITURA ARGENTO
SILVER FINISHING



FINITURA NERA
BLACK FINISHING

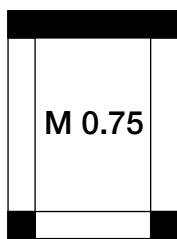

M 0.75

3 LATI ESPOSITIVI
3 GLAZED SIDES

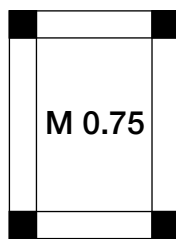

M 0.75

4 LATI ESPOSITIVI
4 GLAZED SIDES

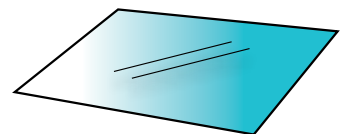

300 X 420 mm

5 PIANI VETRO
5 GLASS SHELVES

P statico	temperatura +2 / +10 °C	EVO 460 - P
P static	temperature +2 / +10 °C	

LATI ESPOSITIVI SIDES GLASSES	RIPIANI VETRO GLASS SHELVES	CONSUMO ELETTRICO ELECTRIC CONSUMPTION	VOLUME IN LITRI VOLUME (LT)	PESO NETTO NET WEIGHT	PESO LORDO GROSS WEIGHT	PREZZO PRICE
3	5	0,2	250	75	85	4.080,00 €
4	5	0,2	250	75	85	4.230,00 €

NT statico	temperatura -15 / -25 °C	EVO 460 - NT
NT static	temperature -15 / -25 °C	

LATI ESPOSITIVI SIDES GLASSES	GRIGLIE REFRIGERATE REFRIGERATED GRIDS	CONSUMO ELETTRICO ELECTRIC CONSUMPTION	VOLUME IN LITRI VOLUME (LT)	PESO NETTO NET WEIGHT	PESO LORDO GROSS WEIGHT	PREZZO PRICE
3	6 (+ kit ripiani vetro)	0,3	250	75	85	5.150,00 €
4	6 (+glass shelves kit)	0,3	250	75	85	5.320,00 €

NFP ventilato	temperatura +10 / -5 °C	EVO 460 - NFP
NFP no-frost	temperature +10 / -5 °C	

LATI ESPOSITIVI SIDES GLASSES	RIPIANI VETRO GLASS SHELVES	CONSUMO ELETTRICO ELECTRIC CONSUMPTION	VOLUME IN LITRI VOLUME (LT)	PESO NETTO NET WEIGHT	PESO LORDO GROSS WEIGHT	PREZZO PRICE
3	5	0,2	255	90	100	4.480,00 €
4	5	0,2	255	100	110	4.660,00 €

NFN ventilato	temperatura +5 / -25 °C	EVO 460 - NFN
NFN no-frost	temperature +5 / -25 °C	

LATI ESPOSITIVI SIDES GLASSES	RIPIANI VETRO GLASS SHELVES	CONSUMO ELETTRICO ELECTRIC CONSUMPTION	VOLUME IN LITRI VOLUME (LT)	PESO NETTO NET WEIGHT	PESO LORDO GROSS WEIGHT	PREZZO PRICE
3	5	0,6	255	95	105	5.460,00 €
4	5	0,6	255	105	115	5.660,00 €

EVO

EVO 460 TOP

460 X 640 X 1500 mm

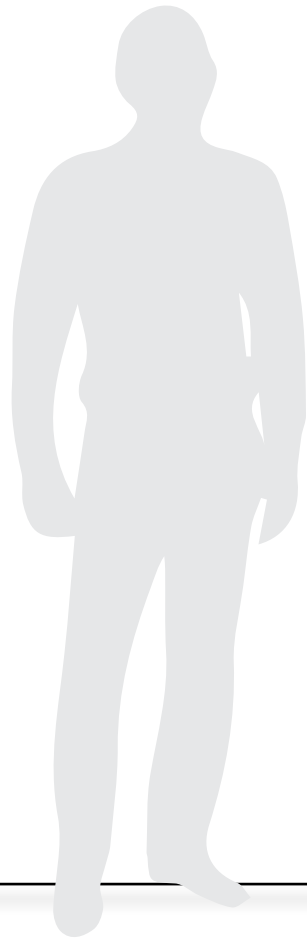

FINITURA BIANCA
WHITE FINISHING



FINITURA BRONZO
BRONZE FINISHING



FINITURA ARGENTO
SILVER FINISHING



FINITURA NERA
BLACK FINISHING

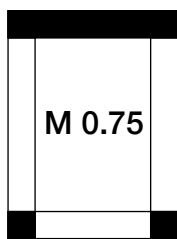

3 LATI ESPOSITIVI
3 GLAZED SIDES

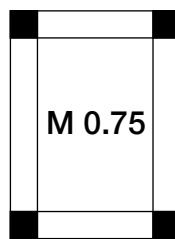

4 LATI ESPOSITIVI
4 GLAZED SIDES

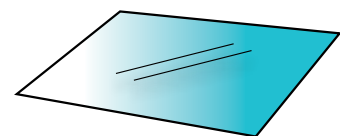

300 X 420 mm

3 PIANI VETRO
3 GLASS SHELVES

P statico temperatura +2 / +10 °C
P static temperature +2 / +10 °C

EVO 460 TOP - P

LATI ESPOSITIVI SIDES GLASSES	RIPIANI VETRO GLASS SHELVES	CONSUMO ELETTRICO ELECTRIC CONSUMPTION	VOLUME IN LITRI VOLUME (LT)	PESO NETTO NET WEIGHT	PESO LORDO GROSS WEIGHT	PREZZO PRICE
3	3	0,1	200	60	68	3.670,00 €
4	3	0,1	200	60	68	3.820,00 €

NT statico temperatura -15 / -25 °C
NT static temperature -15 / -25 °C

EVO 460 TOP - NT

LATI ESPOSITIVI SIDES GLASSES	GRIGLIE REFRIGERATE REFRIGERATED GRIDS	CONSUMO ELETTRICO ELECTRIC CONSUMPTION	VOLUME IN LITRI VOLUME (LT)	PESO NETTO NET WEIGHT	PESO LORDO GROSS WEIGHT	PREZZO PRICE
3	3 (+ kit ripiani vetro)	0,2	200	60	68	4.650,00 €
4	3 (+glass shelves kit)	0,2	200	60	68	4.790,00 €

NFP ventilato temperatura +10 / -5 °C
NFP no-frost temperature +10 / -5 °C

EVO 460 TOP - NFP

LATI ESPOSITIVI SIDES GLASSES	RIPIANI VETRO GLASS SHELVES	CONSUMO ELETTRICO ELECTRIC CONSUMPTION	VOLUME IN LITRI VOLUME (LT)	PESO NETTO NET WEIGHT	PESO LORDO GROSS WEIGHT	PREZZO PRICE
3	3	0,1	204	72	80	4.040,00 €
4	3	0,1	204	80	88	4.200,00 €

NFN ventilato temperatura +5 / -25 °C
NFN no-frost temperature +5 / -25 °C

EVO 460 TOP - NFN

LATI ESPOSITIVI SIDES GLASSES	RIPIANI VETRO GLASS SHELVES	CONSUMO ELETTRICO ELECTRIC CONSUMPTION	VOLUME IN LITRI VOLUME (LT)	PESO NETTO NET WEIGHT	PESO LORDO GROSS WEIGHT	PREZZO PRICE
3	3	0,5	204	77	85	4.930,00 €
4	3	0,5	204	84	92	5.110,00 €

EVO 670

670 X 640 X 1930 mm

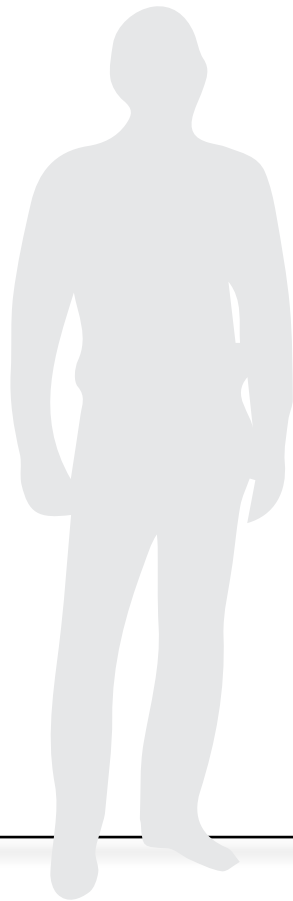

FINITURA BIANCA
WHITE FINISHING

FINITURA BRONZO
BRONZE FINISHING

FINITURA ARGENTO
SILVER FINISHING

FINITURA NERA
BLACK FINISHING

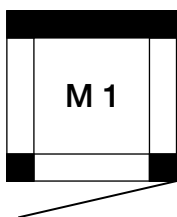

3 LATI ESPOSITIVI
3 GLAZED SIDES

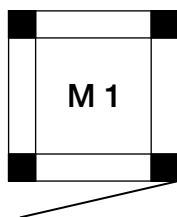

4 LATI ESPOSITIVI
4 GLAZED SIDES

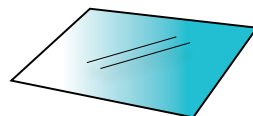

510 X 420 mm

5 PIANI VETRO
5 GLASS SHELVES

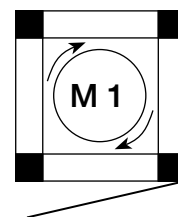

4 LATI ESPOSITIVI
4 GLAZED SIDES

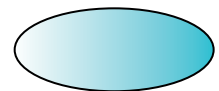

6 PIANI VETRO
6 GLASS SHELVES



1 PIANO SPECCHIO
1 MIRROR SHELVES

P statico temperatura +2 / +10 °C **EVO 670 - P**
P static temperature +2 / +10 °C

LATI ESPOSITIVI SIDES GLASSES	RIPIANI VETRO GLASS SHELVES	CONSUMO ELETTRICO ELECTRIC CONSUMPTION	VOLUME IN LITRI VOLUME (LT)	PESO NETTO NET WEIGHT	PESO LORDO GROSS WEIGHT	PREZZO PRICE
3	5	0,4	430	140	155	4.290,00 €
4	5	0,4	430	157	182	4.450,00 €
RIPIANI ROTANTI ROTATING SHELVES						
4	6 +1 a specchio	0,4	430	140	155	4.870,00 €

NT statico temperatura -15 / -25 °C **EVO 670 - NT**
NT static temperature -15 / -25 °C

LATI ESPOSITIVI SIDES GLASSES	GRIGLIE REFRIGERATE REFRIGERATED GRIDS	CONSUMO ELETTRICO ELECTRIC CONSUMPTION	VOLUME IN LITRI VOLUME (LT)	PESO NETTO NET WEIGHT	PESO LORDO GROSS WEIGHT	PREZZO PRICE
3	6 (+ kit ripiani vetro)	0,7	430	138	153	5.410,00 €
4	6 (+glass shelves kit)	0,7	430	155	180	5.600,00 €

NFP ventilato temperatura +10 / -5 °C **EVO 670 - NFP**
NFP no-frost temperature +10 / -5 °C

LATI ESPOSITIVI SIDES GLASSES	RIPIANI VETRO GLASS SHELVES	CONSUMO ELETTRICO ELECTRIC CONSUMPTION	VOLUME IN LITRI VOLUME (LT)	PESO NETTO NET WEIGHT	PESO LORDO GROSS WEIGHT	PREZZO PRICE
3	5	0,5	405	140	80	4.710,00 €
4	5	0,5	405	159	161	4.900,00 €
RIPIANI ROTANTI ROTATING SHELVES						
4	6 +1 a specchio	0,5	405	140	155	5.360,00 €

NFN ventilato temperatura +5 / -25 °C **EVO 670 - NFN**
NFN no-frost temperature +5 / -25 °C

LATI ESPOSITIVI SIDES GLASSES	RIPIANI VETRO GLASS SHELVES	CONSUMO ELETTRICO ELECTRIC CONSUMPTION	VOLUME IN LITRI VOLUME (LT)	PESO NETTO NET WEIGHT	PESO LORDO GROSS WEIGHT	PREZZO PRICE
3	5	0,8	405	143	158	5.760,00 €
4	5	0,8	405	161	186	5.960,00 €
RIPIANI ROTANTI ROTATING SHELVES						
4	6 +1 a specchio	0,8	405	143	158	6.340,00 €

EVO 670 TOP

670 X 640 X 1500 mm



FINITURA BIANCA
WHITE FINISHING

FINITURA BRONZO
BRONZE FINISHING

FINITURA ARGENTO
SILVER FINISHING

FINITURA NERA
BLACK FINISHING

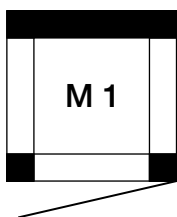

3 LATI ESPOSITIVI
3 GLAZED SIDES

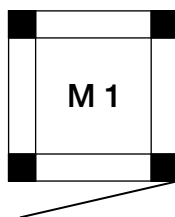

4 LATI ESPOSITIVI
4 GLAZED SIDES

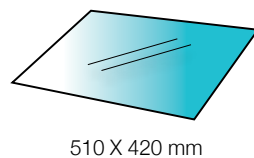

510 X 420 mm

3 PIANI VETRO
3 GLASS SHELVES

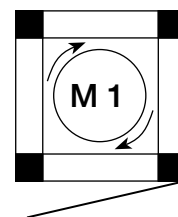

4 LATI ESPOSITIVI
4 GLAZED SIDES



3 PIANI VETRO
3 GLASS SHELVES



1 PIANO SPECCHIO
1 MIRROR SHELVES

P statico temperatura +2 / +10 °C **EVO 670 TOP - P**
P static temperature +2 / +10 °C

LATI ESPOSITIVI SIDES GLASSES	RIPIANI VETRO GLASS SHELVES	CONSUMO ELETTRICO ELECTRIC CONSUMPTION	VOLUME IN LITRI VOLUME (LT)	PESO NETTO NET WEIGHT	PESO LORDO GROSS WEIGHT	PREZZO PRICE
3	3	0,3	344	112	124	3.860,00 €
4	3	0,3	344	125	145	4.010,00 €
RIPIANI ROTANTI ROTATING SHELVES						
4	3 +1 a specchio	0,4	430	140	158	4.330,00 €

NT statico temperatura -15 / -25 °C **EVO 670 TOP - NT**
NT static temperature -15 / -25 °C

LATI ESPOSITIVI SIDES GLASSES	GRIGLIE REFRIGERATE REFRIGERATED GRIDS	CONSUMO ELETTRICO ELECTRIC CONSUMPTION	VOLUME IN LITRI VOLUME (LT)	PESO NETTO NET WEIGHT	PESO LORDO GROSS WEIGHT	PREZZO PRICE
3	3 (+ kit ripiani vetro)	0,6	344	110	122	4.920,00 €
4	3 (+glass shelves kit)	0,6	344	123	143	5.060,00 €

NFP ventilato temperatura +10 / -5 °C **EVO 670 TOP - NFP**
NFP no-frost temperature +10 / -5 °C

LATI ESPOSITIVI SIDES GLASSES	RIPIANI VETRO GLASS SHELVES	CONSUMO ELETTRICO ELECTRIC CONSUMPTION	VOLUME IN LITRI VOLUME (LT)	PESO NETTO NET WEIGHT	PESO LORDO GROSS WEIGHT	PREZZO PRICE
3	3	0,4	324	112	124	4.290,00 €
4	3	0,4	324	121	141	4.430,00 €
RIPIANI ROTANTI ROTATING SHELVES						
4	3 +1 a specchio	0,5	405	140	155	4.760,00 €

NFN ventilato temperatura +5 / -25 °C **EVO 670 TOP - NFN**
NFN no-frost temperature +5 / -25 °C

LATI ESPOSITIVI SIDES GLASSES	RIPIANI VETRO GLASS SHELVES	CONSUMO ELETTRICO ELECTRIC CONSUMPTION	VOLUME IN LITRI VOLUME (LT)	PESO NETTO NET WEIGHT	PESO LORDO GROSS WEIGHT	PREZZO PRICE
3	3	0,6	324	115	127	5.230,00 €
4	3	0,6	324	128	148	5.370,00 €
RIPIANI ROTANTI ROTATING SHELVES						
4	3 +1 a specchio	0,8	405	143	155	5.720,00 €

EVO 900 900 X 640 X 1930 mm



FINITURA BIANCA
WHITE FINISHING



FINITURA BRONZO
BRONZE FINISHING



FINITURA ARGENTO
SILVER FINISHING



FINITURA NERA
BLACK FINISHING

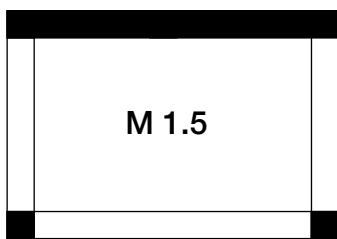

3 LATI ESPOSITIVI
3 GLAZED SIDES

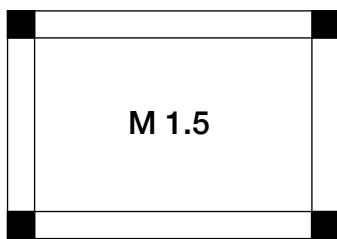

4 LATI ESPOSITIVI
4 GLAZED SIDES

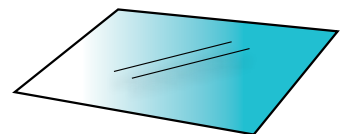

740 X 420 mm

5 PIANI VETRO
5 GLASS SHELVES

P statico temperatura +2 / +10 °C **EVO 900 - P**
P static temperature +2 / +10 °C

LATI ESPOSITIVI SIDES GLASSES	RIPIANI VETRO GLASS SHELVES	CONSUMO ELETTRICO ELECTRIC CONSUMPTION	VOLUME IN LITRI VOLUME (LT)	PESO NETTO NET WEIGHT	PESO LORDO GROSS WEIGHT	PREZZO PRICE
3	5	0,5	620	153	170	5.340,00 €
4	5	0,5	630	166	184	5.630,00 €

NT statico temperatura -15 / -25 °C **EVO 900 - NT**
NT static temperature -15 / -25 °C

LATI ESPOSITIVI SIDES GLASSES	GRIGLIE REFRIGERATE REFRIGERATED GRIDS	CONSUMO ELETTRICO ELECTRIC CONSUMPTION	VOLUME IN LITRI VOLUME (LT)	PESO NETTO NET WEIGHT	PESO LORDO GROSS WEIGHT	PREZZO PRICE
3	6 (+ kit ripiani vetro)	0,7	620	155	173	6.710,00 €
4	6 (+glass shelves kit)	0,8	630	168	186	6.900,00 €

NFP ventilato temperatura +10 / -5 °C **EVO 900 - NFP**
NFP no-frost temperature +10 / -5 °C

LATI ESPOSITIVI SIDES GLASSES	RIPIANI VETRO GLASS SHELVES	CONSUMO ELETTRICO ELECTRIC CONSUMPTION	VOLUME IN LITRI VOLUME (LT)	PESO NETTO NET WEIGHT	PESO LORDO GROSS WEIGHT	PREZZO PRICE
3	5	0,5	590	157	175	5.690,00 €
4	5	0,5	595	166	184	5.880,00 €

NFN ventilato temperatura +5 / -25 °C **EVO 900 - NFN**
NFN no-frost temperature +5 / -25 °C

LATI ESPOSITIVI SIDES GLASSES	RIPIANI VETRO GLASS SHELVES	CONSUMO ELETTRICO ELECTRIC CONSUMPTION	VOLUME IN LITRI VOLUME (LT)	PESO NETTO NET WEIGHT	PESO LORDO GROSS WEIGHT	PREZZO PRICE
3	5	0,7	590	159	177	7.140,00 €
4	5	0,7	595	170	188	7.330,00 €

EVO 900 TOP

900 X 640 X 1500 mm

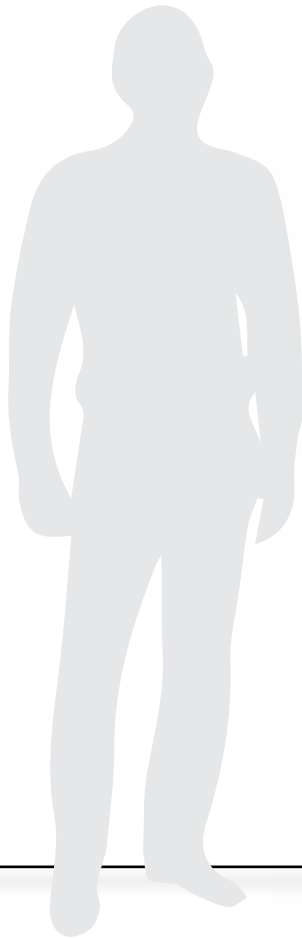

FINITURA BIANCA
WHITE FINISHING



FINITURA BRONZO
BRONZE FINISHING



FINITURA ARGENTO
SILVER FINISHING



FINITURA NERA
BLACK FINISHING

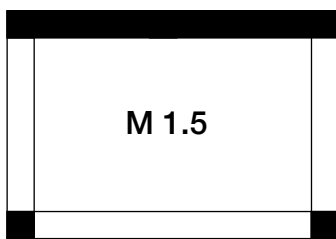

3 LATI ESPOSITIVI
3 GLAZED SIDES

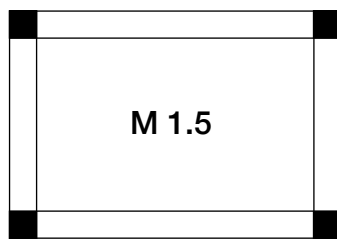

4 LATI ESPOSITIVI
4 GLAZED SIDES

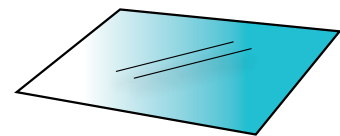

740 X 420 mm

3 PIANI VETRO
3 GLASS SHELVES

P statico temperatura +2 / +10 °C **EVO 900 TOP - P**
P static temperature +2 / +10 °C

LATI ESPOSITIVI SIDES GLASSES	RIPIANI VETRO GLASS SHELVES	CONSUMO ELETTRICO ELECTRIC CONSUMPTION	VOLUME IN LITRI VOLUME (LT)	PESO NETTO NET WEIGHT	PESO LORDO GROSS WEIGHT	PREZZO PRICE
3	3	0,4	490	122	136	4.660,00 €
4	3	0,4	500	132	148	4.820,00 €

NT statico temperatura -15 / -25 °C **EVO 900 TOP - NT**
NT static temperature -15 / -25 °C

LATI ESPOSITIVI SIDES GLASSES	GRIGLIE REFRIGERATE REFRIGERATED GRIDS	CONSUMO ELETTRICO ELECTRIC CONSUMPTION	VOLUME IN LITRI VOLUME (LT)	PESO NETTO NET WEIGHT	PESO LORDO GROSS WEIGHT	PREZZO PRICE
3	3 (+ kit ripiani vetro)	0,6	490	124	138	6.080,00 €
4	3 (+glass shelves kit)	0,6	500	134	150	6.220,00 €

NFP ventilato temperatura +10 / -5 °C **EVO 900 TOP - NFP**
NFP no-frost temperature +10 / -5 °C

LATI ESPOSITIVI SIDES GLASSES	RIPIANI VETRO GLASS SHELVES	CONSUMO ELETTRICO ELECTRIC CONSUMPTION	VOLUME IN LITRI VOLUME (LT)	PESO NETTO NET WEIGHT	PESO LORDO GROSS WEIGHT	PREZZO PRICE
3	3	0,4	470	126	140	5.160,00 €
4	3	0,4	470	136	152	5.320,00 €

NFN ventilato temperatura +5 / -25 °C **EVO 900 TOP - NFN**
NFN no-frost temperature +5 / -25 °C

LATI ESPOSITIVI SIDES GLASSES	RIPIANI VETRO GLASS SHELVES	CONSUMO ELETTRICO ELECTRIC CONSUMPTION	VOLUME IN LITRI VOLUME (LT)	PESO NETTO NET WEIGHT	PESO LORDO GROSS WEIGHT	PREZZO PRICE
3	3	0,5	470	128	142	6.270,00 €
4	3	0,6	470	140	158	6.410,00 €

EVO 26

760 X 760 X 1930 mm

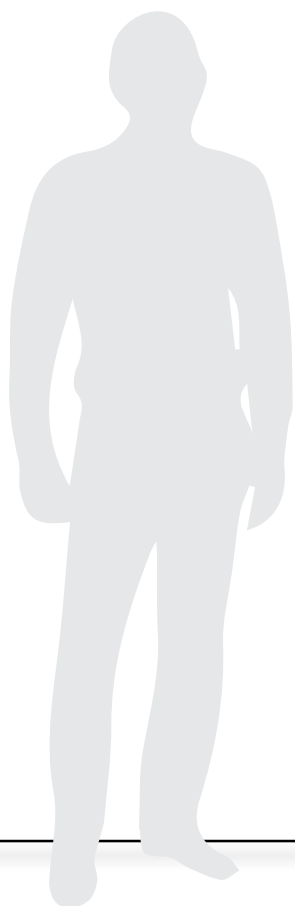

 **FINITURA BIANCA**
WHITE FINISHING

 **FINITURA BRONZO**
BRONZE FINISHING

 **FINITURA ARGENTO**
SILVER FINISHING

 **FINITURA NERA**
BLACK FINISHING

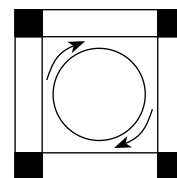

4 LATI ESPOSITIVI
4 GLAZED SIDES

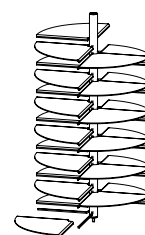

26 RIPIANI Ø 260 mm
26 SHELVES Ø 260 mm

LATI ESPOSITIVI SIDES GLASSES	RIPIANI VETRO GLASS SHELVES	CONSUMO ELETTRICO ELECTRIC CONSUMPTION	VOLUME IN LITRI VOLUME (LT)	PESO NETTO NET WEIGHT	PESO LORDO GROSS WEIGHT	PREZZO PRICE
P statico P static temperatura +2 / +10 °C temperature +2 / +10 °C						EVO 26 - P
4	26	0,3	530	180	198	7.590,00 €
NFP ventilato NFP no-frost temperatura +10 / -5 °C temperature +10 / -5 °C						EVO 26 - NFP
4	26	0,4	530	140	158	8.390,00 €
NFN ventilato NFN no-frost temperatura +5 / -25 °C temperature +5 / -25 °C						EVO 26 - NFN
4	26	0,5	530	150	168	10.170,00 €

900 X 900 X 1930 mm **EVO 32**

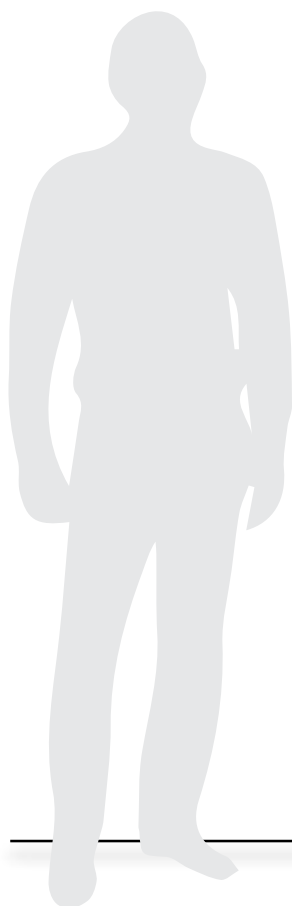

 **FINITURA BIANCA**
WHITE FINISHING

 **FINITURA BRONZO**
BRONZE FINISHING

 **FINITURA ARGENTO**
SILVER FINISHING

 **FINITURA NERA**
BLACK FINISHING

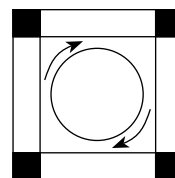

4 LATI ESPOSITIVI
4 GLAZED SIDES

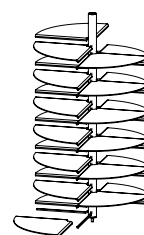

26 RIPIANI Ø 320 mm
26 SHELVES Ø 320 mm

LATI ESPOSITIVI SIDES GLASSES	RIPIANI VETRO GLASS SHELVES	CONSUMO ELETTRICO ELECTRIC CONSUMPTION	VOLUME IN LITRI VOLUME (LT)	PESO NETTO NET WEIGHT	PESO LORDO GROSS WEIGHT	PREZZO PRICE
P statico temperatura +2 / +10 °C P static temperature +2 / +10 °C						EVO 32 - P
4	32	0,3	770	180	198	9.100,00 €
NFP ventilato temperatura +10 / -5 °C NFP no-frost temperature +10 / -5 °C						EVO 32 - NFP
4	32	0,4	770	140	158	10.070,00 €
NFN ventilato temperatura +5 / -25 °C NFN no-frost temperature +5 / -25 °C						EVO 32 - NFN
4	32	0,7	770	150	168	12.220,00 €

MODELLI 1 PORTA MODELS 1 DOOR



EVO 5400



FINITURA BIANCA
WHITE FINISHING



FINITURA BRONZO
BRONZE FINISHING



FINITURA ARGENTO
SILVER FINISHING



FINITURA NERA
BLACK FINISHING

760 X 760 X 1930 mm

1 PORTA ■ 1 DOOR

MODELLO MODELS	VANI COMPARTMENT	P +2 / +10 °C	NT -15 / -25 °C	NP -15 / -25 °C +2 / +10 °C	NFP +10 / -5 °C	NFN +5 / -25 °C	CB +5 / -25 °C +10 / -5 °C
5300 EVO	■	5.560,00 €	/	/	6.490,00 €	7.940,00 €	/
5400 EVO	■	5.760,00 €	/	/	6.590,00 €	8.600,00 €	/
5401 EVO	■	6.250,00 €	/	/	7.120,00 €	8.980,00 €	/

MODELLI 2 PORTE MODELS 2 DOORS

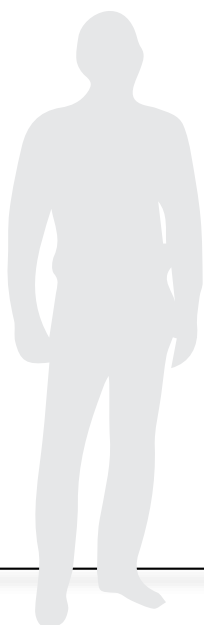







EVO 7400

-  **FINITURA BIANCA**
WHITE FINISHING
-  **FINITURA BRONZO**
BRONZE FINISHING
-  **FINITURA ARGENTO**
SILVER FINISHING
-  **FINITURA NERA**
BLACK FINISHING



1360 X 640 X 1930 mm

2 PORTE ■ 2 DOORS

MODELLO MODELS	VANI COMPARTMENT	P +2 / +10 °C	NT -15 / -25 °C	NP -15 / -25 °C +2 / +10 °C	NFP +10 / -5 °C	NFN +5 / -25 °C	CB +5 / -25 °C +10 / -5 °C
7300 EVO		6.680,00 €	8.030,00 €	/	7.660,00 €	9.920,00 €	/
7400 EVO		6.720,00 €	8.380,00 €	/	7.740,00 €	9.920,00 €	/
7401 EVO		7.100,00 €	/	/	8.250,00 €	11.550,00 €	/
8300 EVO		7.580,00 €	9.010,00 €	9.010,00 €	8.790,00 €	11.790,00 €	10.230,00 €
8400 EVO		7.560,00 €	9.160,00 €	8.830,00 €	8.920,00 €	12.030,00 €	10.450,00 €
8401 EVO		8.800,00 €	/	9.400,00 €	9.610,00 €	13.550,00 €	11.520,00 €

1360 X 760 X 1930 mm

2 PORTE ■ 2 DOORS

MODELLO MODELS	VANI COMPARTMENT	P +2 / +10 °C	NT -15 / -25 °C	NP -15 / -25 °C +2 / +10 °C	NFP +10 / -5 °C	NFN +5 / -25 °C	CB +5 / -25 °C +10 / -5 °C
7300XL		8.160,00 €	/	/	9.390,00 €	12.150,00 €	/
7400XL		8.230,00 €	/	/	9.480,00 €	12.150,00 €	/
7401XL		8.690,00 €	/	/	10.110,00 €	14.140,00 €	/

MODELLI 2 PORTE

MODELS 2 DOORS



FINITURA BIANCA
WHITE FINISHING



FINITURA BRONZO
BRONZE FINISHING



FINITURA ARGENTO
SILVER FINISHING



FINITURA NERA
BLACK FINISHING

EVO 1840

1540 X 760 X 1930 mm

2 PORTE ■ 2 DOORS

MODELLO MODELS	VANI COMPARTMENT	P +2 / +10 °C	NT -15 / -25 °C	NP -15 / -25 °C +2 / +10 °C	NFP +10 / -5 °C	NFN +5 / -25 °C	CB +5 / -25 °C +10 / -5 °C
10300 EVO		10.150,00 €	/	/	11.540,00 €	14.730,00 €	12.790,00 €
10400 EVO		10.290,00 €	/	/	11.700,00 €	15.250,00 €	13.880,00 €
10401 EVO		11.200,00 €	/	/	12.760,00 €	16.120,00 €	14.790,00 €

1590 X 640 X 1930 mm

2 PORTE ■ 2 DOORS

MODELLO MODELS	VANI COMPARTMENT	P +2 / +10 °C	NT -15 / -25 °C	NP -15 / -25 °C +2 / +10 °C	NFP +10 / -5 °C	NFN +5 / -25 °C	CB +5 / -25 °C +10 / -5 °C
1330 EVO		9.730,00 €	12.400,00 €	10.870,00 €	11.490,00 €	14.720,00 €	12.810,00 €
1340 EVO		9.990,00 €	12.830,00 €	11.120,00 €	11.690,00 €	15.480,00 €	13.240,00 €
1341 EVO		11.460,00 €	/	12.620,00 €	12.660,00 €	17.790,00 €	15.230,00 €

1820 X 640 X 1930 mm

2 PORTE ■ 2 DOORS

MODELLO MODELS	VANI COMPARTMENT	P +2 / +10 °C	NT -15 / -25 °C	NP -15 / -25 °C +2 / +10 °C	NFP +10 / -5 °C	NFN +5 / -25 °C	CB +5 / -25 °C +10 / -5 °C
1830 EVO		9.470,00 €	12.460,00 €	10.920,00 €	10.590,00 €	14.220,00 €	12.350,00 €
1840 EVO		10.590,00 €	14.220,00 €	12.350,00 €	10.760,00 €	14.570,00 €	12.630,00 €

MODELLI 3 PORTE

MODELS 3 DOORS

2050 X 640 X 1930 mm

3 PORTE ■ 3 DOORS

MODELLO MODELS	VANI COMPARTMENT	P +2 / +10 °C	NT -15 / -25 °C	NP -15 / -25 °C +2 / +10 °C	NFP +10 / -5 °C	NFN +5 / -25 °C	CB +5 / -25 °C +10 / -5 °C
1230 EVO		10.270,00 €	13.080,00 €	11.710,00 €	12.270,00 €	16.200,00 €	14.040,00 €
1240 EVO		10.340,00 €	13.260,00 €	11.950,00 €	12.740,00 €	16.530,00 €	14.520,00 €
1241 EVO		12.625,00 €	/	13.730,00 €	13.530,00 €	19.060,00 €	16.500,00 €
1535 EVO		7.740,00 €	/	/	9.280,00 €	14.550,00 €	/
1540 EVO		8.700,00 €	/	/	9.730,00 €	15.330,00 €	/
1541 EVO		9.950,00 €	/	11.800,00 €	10.970,00 €	/	12.050,00 €
1544 EVO		9.160,00 €	12.580,00 €	10.060,00 €	10.580,00 €	/	11.620,00 €

2280 X 640 X 1930 mm

3 PORTE ■ 3 DOORS

MODELLO MODELS	VANI COMPARTMENT	P +2 / +10 °C	NT -15 / -25 °C	NP -15 / -25 °C +2 / +10 °C	NFP +10 / -5 °C	NFN +5 / -25 °C	CB +5 / -25 °C +10 / -5 °C
1430 EVO		13.280,00 €	17.760,00 €	15.470,00 €	16.280,00 €	20.910,00 €	18.120,00 €
1440 EVO		13.520,00 €	18.470,00 €	15.990,00 €	16.520,00 €	21.710,00 €	18.720,00 €
1740 EVO		12.000,00 €	/	13.190,00 €	13.700,00 €	/	15.090,00 €

2510 X 640 X 1930 mm

3 PORTE ■ 3 DOORS

MODELLO MODELS	VANI COMPARTMENT	P +2 / +10 °C	NT -15 / -25 °C	NP -15 / -25 °C +2 / +10 °C	NFP +10 / -5 °C	NFN +5 / -25 °C	CB +5 / -25 °C +10 / -5 °C
1630 EVO		14.060,00 €	18.800,00 €	15.620,00 €	16.440,00 €	22.180,00 €	19.230,00 €
1640 EVO		14.320,00 €	19.660,00 €	16.950,00 €	16.680,00 €	23.030,00 €	19.880,00 €
1641 EVO		15.300,00 €	/	18.030,00 €	18.180,00 €	24.850,00 €	21.500,00 €

2740 X 640 X 1930 mm

3 PORTE ■ 3 DOORS

MODELLO MODELS	VANI COMPARTMENT	P +2 / +10 °C	NT -15 / -25 °C	NP -15 / -25 °C +2 / +10 °C	NFP +10 / -5 °C	NFN +5 / -25 °C	CB +5 / -25 °C +10 / -5 °C
2030 EVO		13.960,00 €	18.640,00 €	16.210,00 €	16.280,00 €	21.940,00 €	19.030,00 €
2040 EVO		14.180,00 €	19.400,00 €	16.770,00 €	16.520,00 €	22.780,00 €	19.640,00 €



EVO 6000

1380 X 640 X 1930 mm

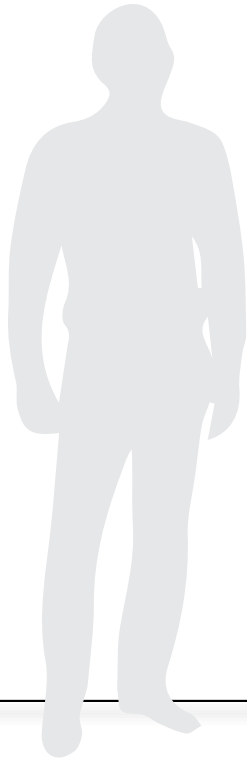

FINITURA BIANCA
WHITE FINISHING



FINITURA BRONZO
BRONZE FINISHING



FINITURA ARGENTO
SILVER FINISHING



FINITURA NERA
BLACK FINISHING

MODELLO MODELS	TEMPERATURA TEMPERATURE	PREZZO PRICE
NFP ventilato NFP no-frost		
EVO 6000 - NFP	+ 10 / -5 °C	10.020,00 €
NFN ventilato NFN no-frost		
EVO 6000 - NFN	+ 5 / -25 °C	12.600,00 €
CB ventilato CB no-frost		
EVO 6000 - CB	+ 5 / -25 °C + 10 / -5 °C	11.590,00 €

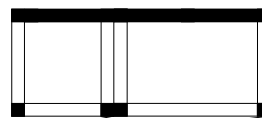

3 LATI ESPOSITIVI
3 GLAZED SIDES

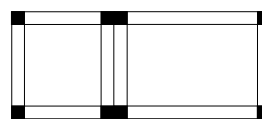

4 LATI ESPOSITIVI
4 GLAZED SIDES

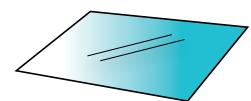

5 PIANI VETRO
5 GLASS SHELVES

EVO CIELO

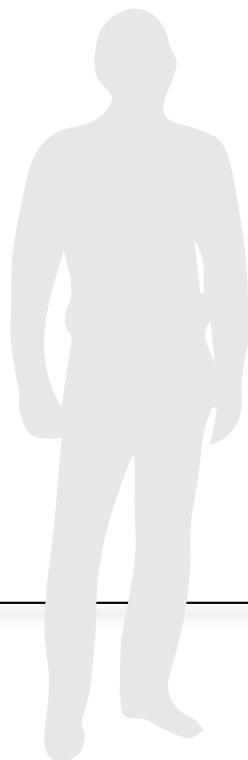

1 PORTA 1 DOOR

EVO CIELO

MODELLO MODELS	DIMENSIONI ESTERNE EXTERNAL DIMENSION	TIPO DI REFRIGERAZIONE REFRIGERATION TYPE	TEMPERATURA TEMPERATURE	PREZZO PRICE
EVO CIELO 76 - NFP	760 X 640 X 1230 mm	ventilato / no-frost	+10 / -5 °C	9.530,00 €
EVO CIELO 76 - NFN	760 X 640 X 1230 mm	ventilato / no-frost	+5 / -25 °C	10.340,00 €
EVO CIELO 90 - NFP	900 X 640 X 1230 mm	ventilato / no-frost	+10 / -5 °C	9.940,00 €
EVO CIELO 90 - NFN	900 X 640 X 1230 mm	ventilato / no-frost	+5 / -25 °C	11.940,00 €

2 PORTA 2 DOORS

EVO CIELO

MODELLO MODELS	DIMENSIONI ESTERNE EXTERNAL DIMENSION	TIPO DI REFRIGERAZIONE REFRIGERATION TYPE	TEMPERATURA TEMPERATURE	PREZZO PRICE
EVO CIELO 136 - NFP	1360 X 640 X 1230 mm	ventilato / no-frost	+10 / -5 °C	10.750,00 €
EVO CIELO 136 - NFN	1360 X 640 X 1230 mm	ventilato / no-frost	+5 / -25 °C	13.510,00 €
EVO CIELO 156 - NFP	1560 X 640 X 1230 mm	ventilato / no-frost	+10 / -5 °C	12.720,00 €
EVO CIELO 156 - NFN	1560 X 640 X 1230 mm	ventilato / no-frost	+5 / -25 °C	16.070,00 €

MODELLI COMPONENTI

SPECIAL MODELS



1

3

CREA IL TUO MODELLO EVO

SCEGLI TRA I MODULI E COMPONI LA TUA VETRINA

CREATE YOUR EVO MODEL

CHOOSE BETWEEN THE MODULES AND COMPOSE YOUR SHOWCABINET



EVO 460 1 900

1360 X 640 X 1930 mm

EVO 7000 1 670

2030 X 640 X 1930 mm

MODELLI PERSONALIZZABILI

SPECIAL MODELS



PERSONALIZZA
IL TUO MODELLO EVO
CON TEXTURE DI DESIGN
CUSTOMIZE
YOUR EVO MODEL
WITH DESIGN TEXTURE



DIMENSIONI EVO

DIMENSIONS EVO LINE

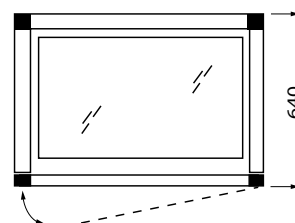
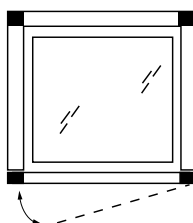
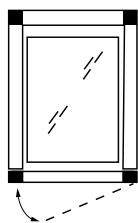
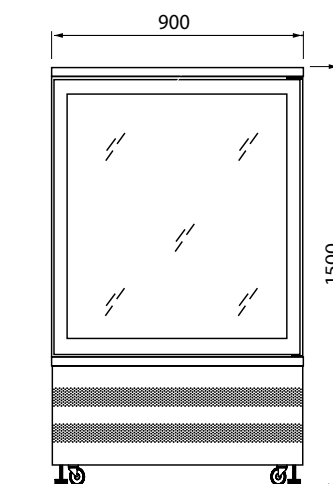
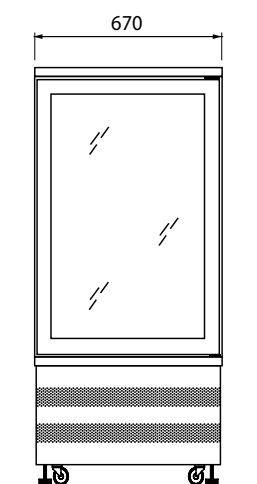
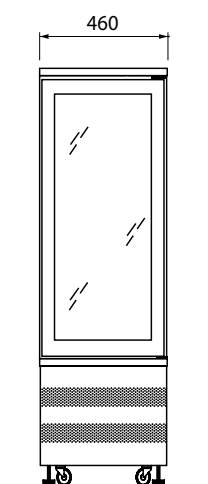
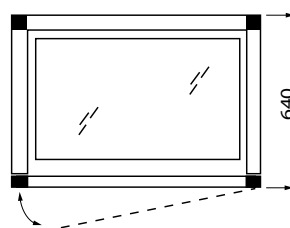
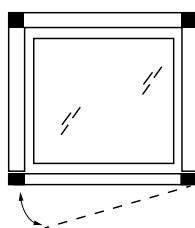
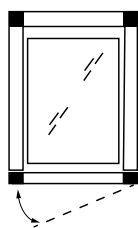
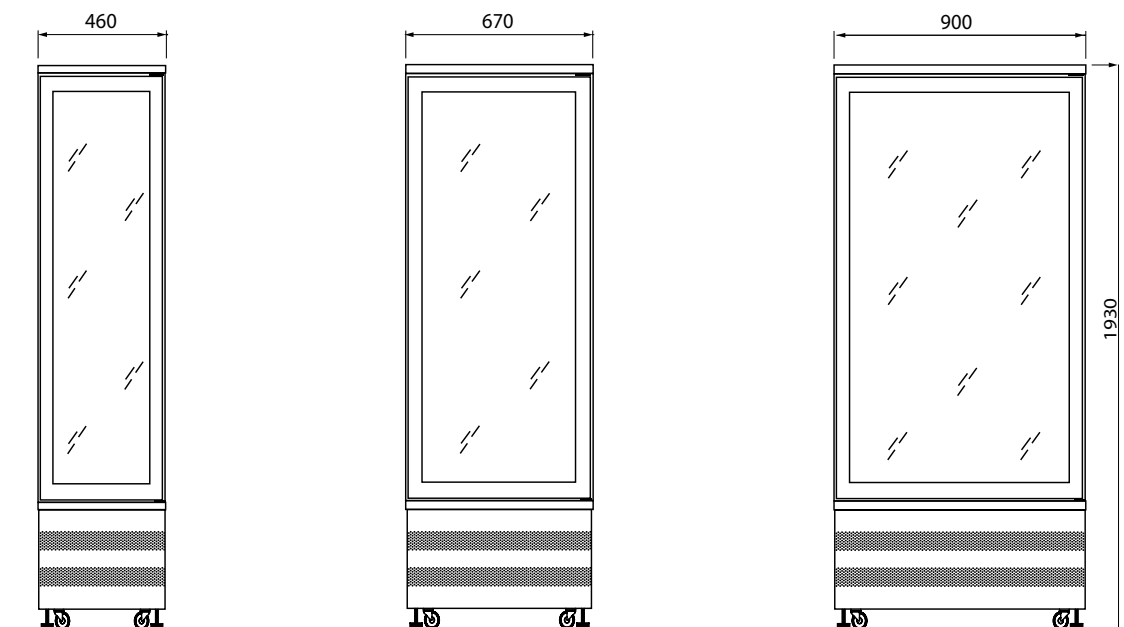









*wine*line

WINE ■ LINE

850 X 760 X 2225 mm

WINE 1

						
NFP	0/+20 °C	1	0,90	740	315 - 345	10.700,00 €



SILVER



WHITE



BLACK

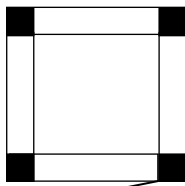







4 LATI ESPOSITIVI
4 GLAZED SIDES



120 BOTTIGLIE
120 BOTTLES

1720 X 760 X 2225 mm

WINE 2

						
NFP	0/+20 °C	2	0,90	1480	340 - 355	19.360,00 €



SILVER



WHITE



BLACK

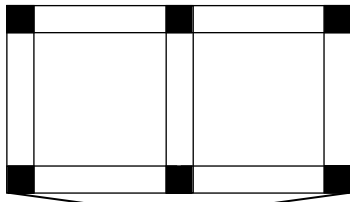

4 LATI ESPOSITIVI
4 GLAZED SIDES



240 BOTTIGLIE
240 BOTTLES

LEGENDA

KEY



STATIC

Refrigerazione statica non ventilata su serie NT o parzialmente ventilata su serie P e PV

Static refrigeration system on NT line or partially ventilated on P or PV



NO-FROST

Refrigerazione ventilata su serie NFP, NFN, NFA, NFNA, FL
No frost system of refrigeration for NFP, NFN, NFA, NFNA, FL



Campo lavoro espresso in gradi Celsius del frigorifero
Range of temperature in °C



Numero di compressori montati
N° of compressors



Consumo elettrico del compressore in Kw/h
Compressor power consumption in Kw/h



Volume in litri del vano di conservazione
Inner capacity in lt



Peso della vetrina, viene indicato il peso lordo e netto
Gross and net cabinet's weight.



Costo in euro tasse e optional esclusi
€ price (taxes and options excluded)



Sbrinamento automatico: gas caldo o elettrico
Automatic de-frost: hot gas or electric



Sbrinamento manuale per fermo macchina
Manual de-frost for downtime



Condensazione ad acqua o mix aria acqua
Water condensation system or water-air system



Voltaggio speciale: V 110/1/60 - 220/1/60 hz
Special voltage: V 110/1/60hz - 220/1/60 hz



Molla per chiusura automatica della porta
Hinges for automatic closing doors



Kit conservazione cioccolato disponibile sulle vetrine della serie P

Chocolate kit for pralines storage



Ripiani per monoporzioni in plexiglass con fori porta coppe in misure standard o custom

Single-portion plexi-glass shelves standard or on demand



Serratura a chiave per porta (non disponibile su serie SLIDING)

Door lock (not available on sliding doors)



Cassonetto in cianocrilato retroilluminato neutro su richiesta personalizzazioni con logo cliente

Semi transparent lighting box, customized on demand with logos.



Rivestimento in vero legno verniciato a campione. Disponibile anche in essenze a richiesta

Covering with wood painted on demand or nobles essences.



CR

Finitura esterna brillantata effetto cromo in acciaio AISI 304 BA supermirror effetto specchio

External finish chrome, stainless steel AISI 304 BA super mirror effect



BA

Finitura interna in acciaio AISI 304 BA supermirror effetto specchio

Inner finish stainless steel AISI 304 BA super mirror effect



SILVER

Finitura esterna in alluminio ossidato grigio e lamiera plastificata in abbinamento

External finish anodized aluminum silver and inner finish white skinplate



BRONZE

Finitura esterna in alluminio ossidato bronzo e lamiera plastificata in abbinamento

External finish anodized aluminum bronze and inner finish white skinplate



Finitura esterna verniciata a campione

External finish RAL colour of your choice



WHITE

Finitura esterna verniciata colore bianco con lamiera plastificata in abbinamento

External finish white paint and inner finish white skinplate



BLACK

Finitura esterna in alluminio ossidato nero opaco e lamiera plastificata in abbinamento

External finish anodized aluminum black and inner finish white skinplate



Illuminazione interna a Led con tubi T8 ad alimentatore interno

LED light kit with T8 tubes and inner power-pack

















ACCESSORI

OPTIONS

	<p>Versione cioccolato (+15/+18°C; umidità: 35/55%) <i>Chocolate version</i> (+15/+18°C; humidity: 35/55%)</p>	700,00 €		<p>Voltaggio speciale <i>Special voltage</i></p>	<p>115 V 60Hz 220 V 60Hz</p>	<p>530,00 € 300,00 €</p>
	<p>Ripiano in vetro o griglia con supporti <i>Glass ledge or grid shelf</i> <i>with supports</i></p>	<p>M 0,75 100,00 € M 1 100,00 € M 1,5 130,00 €</p>		<p>n. 6 ripiani n. 6 ledges Kit ripiani in vetro per vetrina statica (NT) <i>Kit glass ledges for</i> <i>static showcase (NT)</i></p>	<p>M 0,75 M 1 M 1,5</p>	<p>590,00 € 590,00 € 760,00 €</p>
	<p>piano di lavoro per SBM <i>work table for SBM</i></p>	<p>0 SBM 1.250,00 € 1 SBM 1.250,00 € 2 SBM 1.450,00 € 3 SBM 1.640,00 € 4 SBM 1.950,00 €</p>		<p>Imballo in legno <i>Packing wooden crate</i></p>	<p>M 0,75 M 1 M 1,5 M 2</p>	<p>440,00 € 590,00 € 740,00 € 910,00 €</p>
	<p>Cassonetto luminoso <i>Lighting box</i></p>	<p>1P 410,00 € 2P 530,00 € 3P 760,00 €</p>		<p>Tubi per ganci <i>Hanging tubes for hooks</i></p>	<p>M 1 M 1,5 M 2</p>	<p>310,00 € 440,00 € 580,00 €</p>
	<p>LED a porta - led tube cm 60 350,00 € cm 90 360,00 € Kit Lampade LED (standard ex: glassy) cm 120 410,00 € <i>Kit LED lamps</i> (for Wider) cm 150 440,00 €</p>			<p>Versione tropicalizzata <i>Tropical version</i></p>		540,00 €
	<p>Visualizzatore umidità a Hr:75%-85% <i>Preset humidity display at 75%-85%</i></p>	1.100,00 €		<p>Serratura <i>Lock</i></p>		300,00 €
	<p>Ripiano per monoporzioni <i>Single-portion shelf</i></p>	<p>M 0,75 250,00 € M 1 290,00 € M 1,5 350,00 €</p>		<p>Motore remoto (esclusa Wider collection) <i>Remote power unit</i> <i>(Wider line excluded)</i></p>		680,00 €

ACCESSORI

OPTIONS

 <p>Allarme porta aperta <i>Open door alarm</i></p> <p>210,00 €</p>	 <p>Rivestimento in legno <i>Covering with wood</i></p> <p>2.800,00 €</p>
 <p>Cerniera automatica <i>Automatic closing door (hinge)</i></p> <p>120,00 €</p>	 <p>Colori personalizzati RAL <i>Special colors RAL</i></p> <p>M ≤ 0,75 1.730,00 € M ≤ 2 2.140,00 € M ≤ 4,5 2.800,00 €</p>
 <p>Vetro porta "no-fog" <i>"no-fog" glass door</i></p> <p>M 0,75 - 2000 490,00 € M 1 - 4000 580,00 € M 1,5 - 9000 650,00 €</p>	 <p>Finitura esterna cromata <i>Chrome finish</i></p> <p>CROMO</p>  <p>Finitura esterna Acciaio Satinato Aisi 304 <i>Brushed Steel Aisi 304 external finishing</i></p> <p>STEEL</p> <p>a porta 550,00 €</p>
 <p>Quadro comandi elettronico superiore (per statiche) <i>Upper electronic thermostat (for static)</i></p> <p>460,00 €</p>	 <p>Finitura esterna bianca laccato <i>White lacquered external finishing</i></p> <p>WHITE</p>  <p>Finitura esterna nera opaco <i>Matt black external finishing</i></p> <p>BLACK</p> <p>a porta 550,00 €</p>
 <p>Valvola espansione <i>Expansion valve</i></p> <p>410,00 €</p>	 <p>Finitura interna acciaio specchio (BA) <i>Inner finish in stainless steel mirror effect</i></p> <p>SPECCHIO MIRROR</p> <p>300,00 €</p>
 <p>Gruppo condensazione ad acqua <i>Water condensation system</i></p> <p>1.280,00 €</p>	 <p>Piano per R26 o per R32 <i>Shelf for R26 o R32</i></p> <p>70,00 €</p>
 <p>Allarme temperatra condensatore <i>Condenser temperature alarm</i></p> <p>370,00 €</p>	 <p>Regolatore velocità ventole <i>Fan speed controller</i></p> <p>300,00 €</p>



R ■ L I N E

Le vetrine della serie "R" offrono la miglior visibilità al prodotto, grazie al particolare design a chiocciola del castello rotante possono essere ospitate fino a 52 torte. Disponibile in due famiglie R26 per torte con diametro fino a 26 cm e R32 per diametri fino a 32 cm. La completezza della gamma, con temperature di conservazione sia positive (range -5°/+25°C) sia negative (range +5°/-25°C), con dimensioni da 76 a 178 cm ne fanno lo strumento ideale per chi cerca una vetrina che offra un impatto al prodotto difficilmente superabile.

TECNOLOGIA

RIPIANI GIREVOLI SPECIALI

Tutte le vetrine della serie R sono dotate di sbrinatorio automatico: elettrico per la serie a conservazione positiva, a gas caldo per la serie negativa. Dotate di vetrate a 2 o 3 lastre a secondo del modello e con camere a gas inerte garantiscono il più efficiente isolamento termico.

La corretta ed uniforme conservazione viene garantita dal sistema no-frost. Stop ventole e stop castello rotante all'apertura della porta permettono un facile accesso per il carico o scarico della vetrina impedendo un facile afflusso di aria calda verso l'interno.

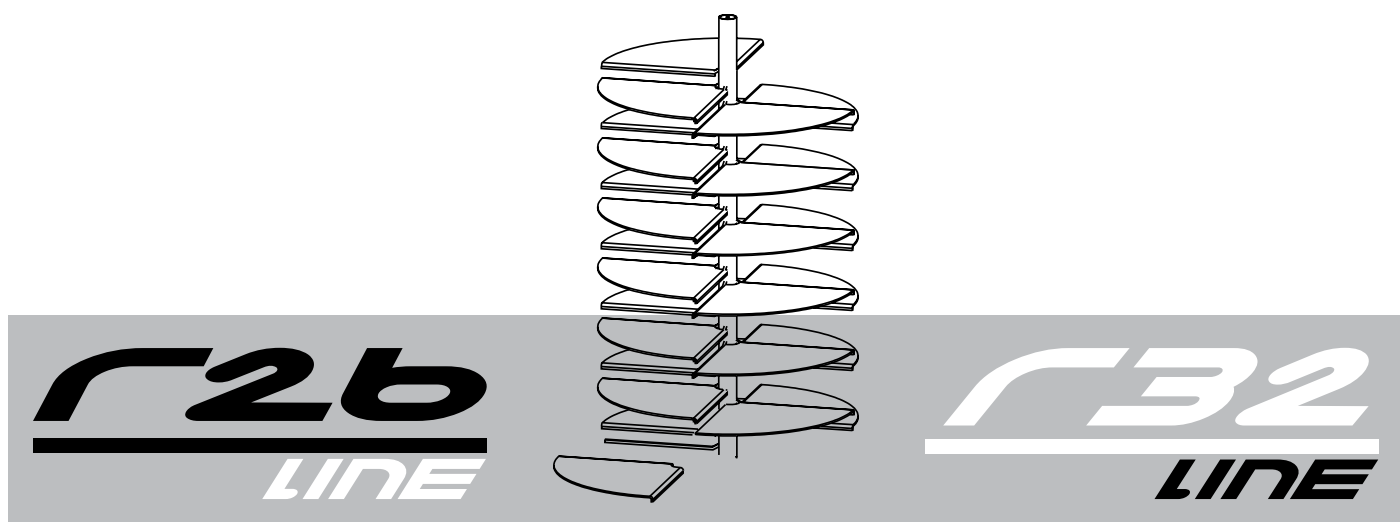

The "R" line cabinets offer the best visibility to the product; this is possible thanks to the special design of rotating shelves; they can show till 52 cakes.

It's available in two different versions, R26 for cakes with diameter 26 cm and R32 for cakes with diameter 32 cm.

The possibility to have positive and negative storage temperatures, 1 or 2 doors from 76 cm to 178 cm length, makes it the perfect showcase for anyone searching for the unbeatable effect in the shop.

TECHNOLOGY

SPECIAL ROTATING SHELVES

All the showcases of the R line are equipped with automatic defrost:

electric for the positive series, hot gas for the negative series.







Depending on the model, the glasses are made of 2 or 3 plates with inert gas compartments for ensuring the best thermic isolation.

The proper and uniform conservation is guarantee by No-Frost system.

When the door is open, fans and rotating shelves stop, so it's easy to load and unload the cabinet avoiding warm air inside it.

760 X 760 X 1910 mm

R26

							
P		+2 / +10 °C	1	0,28	530	130 - 148	5.650,00 €
NFP		+10 / -5 °C	1	0,42	530	140 - 158	6.250,00 €
NFN		+5 / -25 °C	1	0,55	530	150 - 168	7.580,00 €

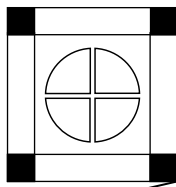

26 RIPIANI Ø 260 mm
26 SHELVES Ø 260 mm
4 LATI ESPOSITIVI
4 GLAZED SIDES



SILVER



BRONZE









AUTO



900 X 900 X 1910 mm

R32

							
P		++2 / +10 °C	1	0,28	770	140 - 160	6.780,00 €
NFP		+10 / -5 °C	1	0,42	770	150 - 170	7.490,00 €
NFN		+5 / -25 °C	1	0,55	770	160 - 180	9.080,00 €

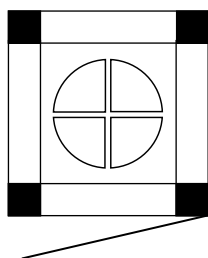

26 RIPIANI Ø 320 mm
26 SHELVES Ø 320 mm
4 LATI ESPOSITIVI
4 GLAZED SIDES



SILVER



BRONZE









AUTO



R26/2

1500 X 760 X 1910 mm

							
P	+2 / +10 °C	2	0,96	1260	315 - 345	9.180,00 €	
NFP	+10 / -5 °C	2	1,20	1260	320 - 350	10.270,00 €	
NFN	+5 / -25 °C	2	1,40	1260	330 - 360	12.660,00 €	
CB	+5 / -25 °C +10 / -5 °C	2	1,00	1260	325 - 355	11.720,00 €	

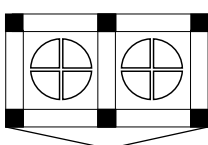

26 X 2 RIPIANI Ø 260 mm
26 X 2 SHELVES Ø 260 mm

4 LATI ESPOSITIVI
4 GLAZED SIDES



SILVER



BRONZE

SU RICHIESTA ON REQUEST

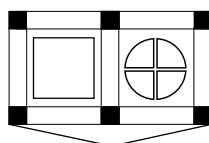
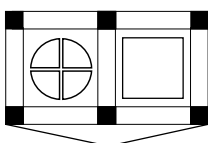







AUTO



R32/2

1780 X 900 X 1910 mm

							
P	+2 / +10 °C	2	0,96	1650	315 - 345	11.020,00 €	
NFP	+10 / -5 °C	2	1,20	1650	320 - 350	12.330,00 €	
NFN	+5 / -25 °C	2	1,40	1650	330 - 360	15.210,00 €	
CB	+5 / -25 °C +10 / -5 °C	2	1,00	1650	325 - 355	14.060,00 €	

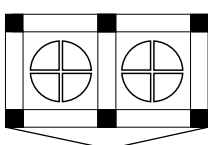

26 X 2 RIPIANI Ø 320 mm
26 X 2 SHELVES Ø 320 mm

4 LATI ESPOSITIVI
4 GLAZED SIDES



SILVER



BRONZE

SU RICHIESTA ON REQUEST

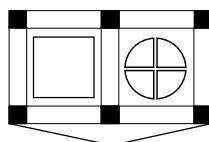
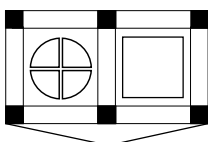







AUTO



1500 X 760 X 1910 mm

R26/2 1M

							
P	+2 / +10 °C	2	0,80	1270	315 - 345	10.560,00 €	
NFP	+10 / -5 °C	2	0,68	1270	320 - 350	11.830,00 €	
NFN	+5 / -25 °C	2	1,20	1270	330 - 360	14.150,00 €	

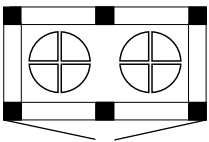

26 X 2 RIPIANI Ø 260 mm
26 X 2 SHELVES Ø 260 mm

4 LATI ESPOSITIVI
4 GLAZED SIDES



SILVER



BRONZE

SU RICHIESTA ON REQUEST

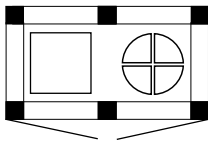
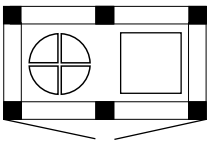







AUTO



1780 X 900 X 1910 mm

R32/2 1M

							
P	+2 / +10 °C	2	0,80	1650	315 - 345	12.650,00 €	
NFP	+10 / -5 °C	2	0,68	1650	320 - 350	14.190,00 €	
NFN	+5 / -25 °C	2	1,20	1650	330 - 360	16.980,00 €	

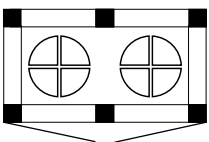

26 X 2 RIPIANI Ø 320 mm
26 X 2 SHELVES Ø 320 mm

4 LATI ESPOSITIVI
4 GLAZED SIDES



SILVER



BRONZE

SU RICHIESTA ON REQUEST

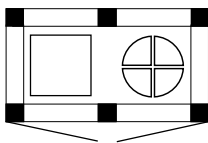
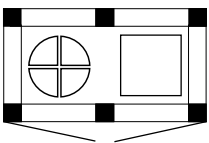

AUTO







TUTTI I MODELLI
DI QUESTA LINEA
SONO REALIZZABILI
NELLA VERSIONE TOP,
CON ALTEZZA 1220 - 1270 MM

ALL GLASSY LINE MODELS
ARE AVAILABLE IN THE TOP
VERSION,
WITH HEIGHT 1220 - 1270 MM

glassy
line

G L A S S Y
L I N E

Con più di 100 modelli a listino la linea glassy è la più completa presente nel mercato. Per la varietà di dimensioni, lati espositivi, temperatura di conservazione, tipo di refrigerazione, materiali, colori, accessori ed opzioni è in grado di soddisfare tutte le esigenze richieste. Dalle piccole esigenze a quelle più importanti è possibile trovare all'interno della linea il modello che può soddisfare qualsiasi richiesta.

Dimensioni a partire da 46 cm fino a quasi 3 mt, altezze a partire da 120 cm, profondità di 55, 64 e 76 cm garantiscono al cliente finale l'ottimizzazione degli spazi disponibili.

Per ogni modello è possibile scegliere quanti e quali lati vetro, le vetrine sono a doppio vetro per le macchine a conservazione in positivo, triplo vetro basso emissivo e doppia camera con gas inerte e resistenza anti condensa per le serie NFN e NT.

E' possibile scegliere il tipo di refrigerazione tra: positivo statico, positivo ventilato, negativo statico e negativo ventilato o in versione combinata per avere due o più temperature di conservazione nello stesso mobile. Per i climi più caldi è disponibile inoltre l'opzione tropicalizzazione. Per chi ne ha la necessità tutte le vetrine della serie 'Glassy' possono essere fornite con motore a distanza o condensazione H2O.

L'ampia scelta di colori e materiali rende possibile l'integrazione armonica di una vetrina 'Glassy' all'interno dei più diversi ambienti di vendita.

With a range of more than 100 models, the 'Glassy' Line is the most complete on the market. For the variety of sizes, exhibition sides, storage temperature, type of refrigeration, materials, colours, options and accessories is able to meet all the demands of the market. It is possible within the line to find the model that can satisfy any request.

Dimensions from 46 cm up to almost 3 meters length, height from 120 cm, depth from 55, 64 and 76 cm can ensure the final customer the optimization of the available spaces.

For each model, you can choose how many and which glass sides, double-glazed for positive temperature, and triple-glazed low-emissivity and double room with inert gas and anti-condensation resistance for the series NFN and NT.

The cooling can be chosen: positive static, positive ventilated, negative static and negative ventilated or combined version to have two or more storage temperatures in the same display. For warmer environments it is also available the option tropical. For those who need the 'Glassy' line showcases can be supplied with remote engine or H2O condensation system.









The wide range of colours and materials makes possible the harmonious integration of a 'Glassy' Line showcase within the most diverse locations.



TUTTI I MODELLI STATICI E NO-FROST SONO DISPONIBILI NELLA VERSIONE "TOP" (ALTEZZA 1220 mm / 2 RIPIANI)
ALL OUR STATIC AND NO-FROST MODELS ARE AVAILABLE IN THE "TOP" VERSION (HEIGHT 1220 mm / 2 SHELVES)

460 X 640 X 1910 mm

2100

 						
P	+2 / +10 °C	1	0,16	250	75 - 85	2.440,00 €
NT	-15 / -25 °C	1	0,28	250	75 - 86	2.500,00 €
NFP	+10 / -5 °C	1	0,16	250	75 - 85	2.510,00 €
NFN	+5 / -25 °C	1	0,45	250	80 - 90	2.720,00 €

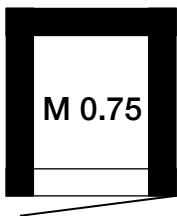

1 LATO ESPOSITIVO
1 4 GLAZED SIDE

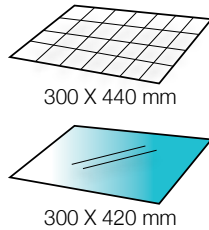

5 GRIGLIE
5 GRIDS
or
5 PIANI VETRO
5 GLASS SHELVES



SILVER





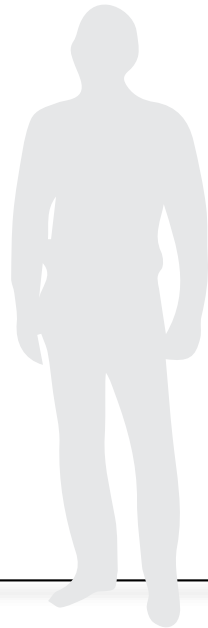





BRONZE



460 X 640 X 1910 mm

2200

 						
P	+2 / +10 °C	1	0,16	250	75 - 85	2.530,00 €
NT	-15 / -25 °C	1	0,28	250	75 - 85	2.930,00 €
NFP	+10 / -5 °C	1	0,16	250	83 - 93	2.730,00 €
NFN	+5 / -25 °C	1	0,45	250	83 - 95	3.250,00 €

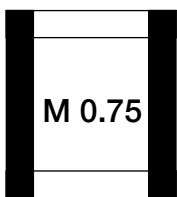

2 LATI ESPOSITIVI
2 GLAZED SIDES

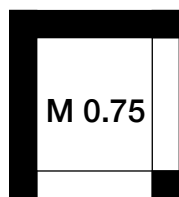

2 LATI ESPOSITIVI
2 GLAZED SIDES

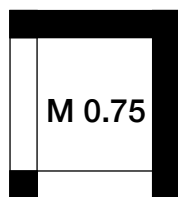

2 LATI ESPOSITIVI
2 GLAZED SIDES

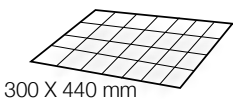

5 GRIGLIE 5 GRIDS or **5 PIANI VETRO 5 GLASS SHELVES**

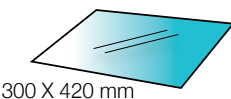

300 X 420 mm



SILVER





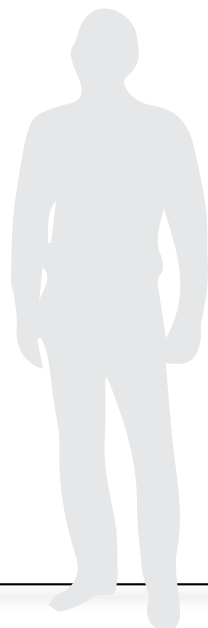



BRONZE



2300

460 X 640 X 1910 mm

							
P	+2 / +10 °C	1	0,16	250	75 - 85	2.550,00 €	
NT	-15 / -25 °C	1	0,28	250	75 - 85	3.240,00 €	
NFP	+10 / -5 °C	1	0,20	255	90 - 100	2.790,00 €	
NFN	+5 / -25 °C	1	0,60	255	95 - 105	3.550,00 €	

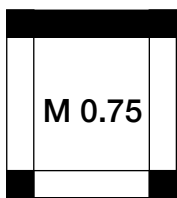

3 LATI ESPOSITIVI
3 GLAZED SIDES

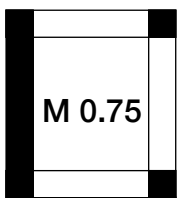

3 LATI ESPOSITIVI
3 SGLAZED SIDES

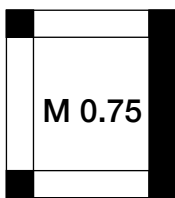

3 LATI ESPOSITIVI
3 GLAZED SIDES

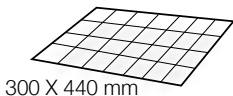

300 X 440 mm

5 GRIGLIE 5 GRIDS or 5 PIANI VETRO 5 GLASS SHELVES

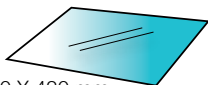

300 X 420 mm



SILVER









BRONZE



2400

460 X 640 X 1910 mm

							
P	+2 / +10 °C	1	0,16	250	75 - 85	2.560,00 €	
NT	-15 / -25 °C	1	0,28	250	75 - 86	3.450,00 €	
NFP	+10 / -5 °C	1	0,20	255	100 - 110	2.870,00 €	
NFN	+5 / -25 °C	1	0,60	255	105 - 115	3.750,00 €	

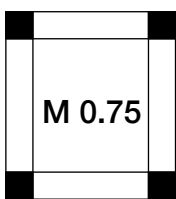

4 LATI ESPOSITIVI
4 GLAZED SIDES

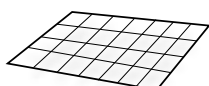

300 X 440 mm

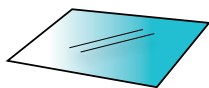

300 X 420 mm

5 GRIGLIE
5 GRIDS
or
5 PIANI VETRO
5 GLASS SHELVES



SILVER



BRONZE



670 X 640 X 1910 mm

4100

STATIC NO Frost	TEMPERATURE	DOOR	POWER (KW)	CAPACITY (LT)	WEIGHT (KG)	PRICE (€)
P	+2 / +10 °C	1	0,26	400	116 - 131	2.690,00 €
NT	-15 / -25 °C	1	0,40	400	117 - 132	2.790,00 €
NFP	+10 / -5 °C	1	0,40	380	120 - 132	2.970,00 €
NFN	+5 / -25 °C	1	0,50	380	122 - 137	3.460,00 €

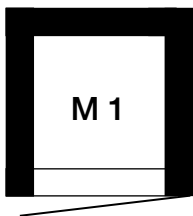

**1 LATO ESPOSITIVO
1 GLAZED SIDE**

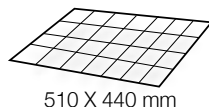

510 X 440 mm

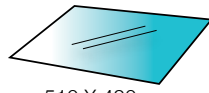

510 X 420 mm

**5 GRIGLIE
5 GRIDS
or
5 PIANI VETRO
5 GLASS SHELVES**



SILVER



BRONZE

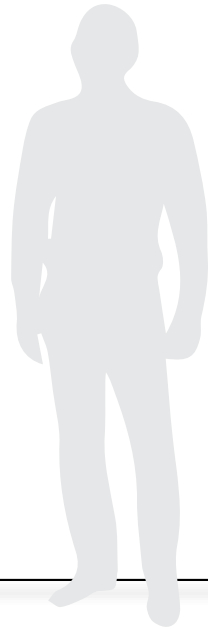

*modelli statici 1860 mm
static model 1860 mm

670 X 640 X 1910 mm

4200

STATIC NO Frost	TEMPERATURE	DOOR	POWER (KW)	CAPACITY (LT)	WEIGHT (KG)	PRICE (€)
P	+2 / +10 °C	1	0,28	420	130 - 145	2.960,00 €
NT	-15 / -25 °C	1	0,55	420	127 - 142	3.400,00 €
NFP	+10 / -5 °C	1	0,42	400	130 - 145	3.250,00 €
NFN	+5 / -25 °C	1	0,65	400	133 - 148	4.220,00 €

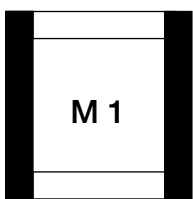

**2 LATI ESPOSITIVI
2 GLAZED SIDES**

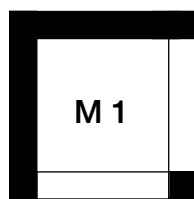

**2 LATI ESPOSITIVI
2 GLAZED SIDES**

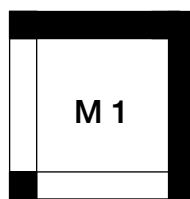

**2 LATI ESPOSITIVI
2 GLAZED SIDES**

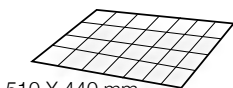

510 X 440 mm

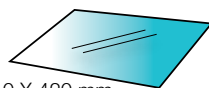

510 X 420 mm

5 GRIGLIE 5 GRIDS or 5 PIANI VETRO 5 GLASS SHELVES



SILVER





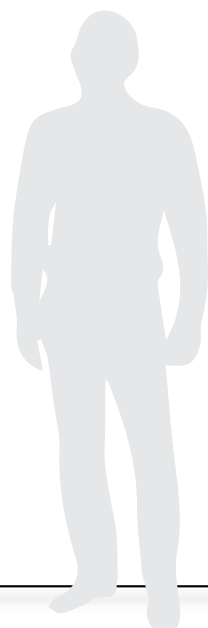



BRONZE



*modelli statici 1860 mm
static model 1860 mm

4300

670 X 640 X 1910 mm

							
P	+2 / +10 °C	1	0,40	430	140 - 155	3.010,00 €	
NT	-15 / -25 °C	1	0,70	430	138 - 153	3.700,00 €	
NFP	+10 / -5 °C	1	0,50	405	140 - 155	3.320,00 €	
NFN	+5 / -25 °C	1	0,80	405	143 - 158	4.540,00 €	

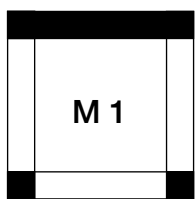

3 LATI ESPOSITIVI
3 GLAZED SIDES

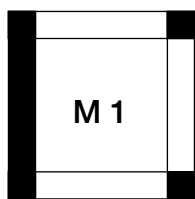

3 LATI ESPOSITIVI
3 GLAZED SIDES

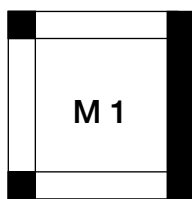

3 LATI ESPOSITIVI
3 GLAZED SIDES

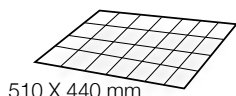

510 X 440 mm

5 GRIGLIE 5 GRIDS or **5 PIANI VETRO 5 GLASS SHELVES**

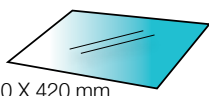

510 X 420 mm



SILVER









BRONZE



*modelli statici 1860 mm
static model 1860 mm

4400

670 X 640 X 1910 mm

							
P	+2 / +10 °C	1	0,40	450	157 - 182	3.030,00 €	
NT	-15 / -25 °C	1	0,75	450	155 - 180	3.770,00 €	
PV	+10 / +2 °C	1	0,50	430	157 - 182	3.130,00 €	
NFP	+10 / -5 °C	1	0,50	430	159 - 184	3.360,00 €	
NFN	+5 / -25 °C	1	0,80	430	161 - 186	4.650,00 €	

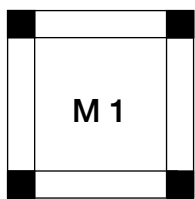

4 LATI ESPOSITIVI
4 GLAZED SIDES

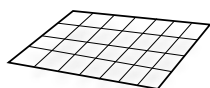

510 X 440 mm

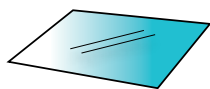

510 X 420 mm

5 GRIGLIE
5 GRIDS

or

5 PIANI VETRO
5 GLASS SHELVES



SILVER









BRONZE



*modelli statici 1860 mm
static model 1860 mm

670 X 640 X 1910 mm

4401

							
P		+2 / +10 °C	1	0,40	450	165 - 190	3.320,00 €
PV		+10 / +2 °C	1	0,50	430	165 - 190	3.470,00 €
NFP		+10 / -5 °C	1	0,50	430	167 - 192	3.810,00 €
NFN		+5 / -25 °C	1	0,85	430	169 - 195	5.060,00 €

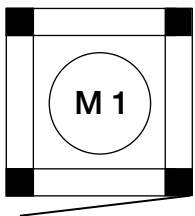

4 LATI ESPOSITIVI
4 GLAZED SIDES

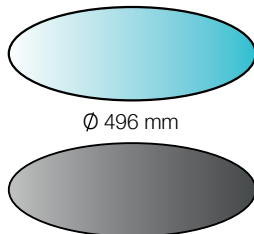



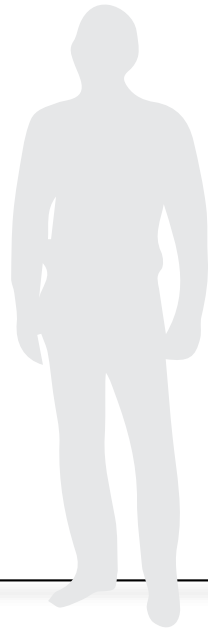



6 PIANI VETRO
6 GLASS SHELVES
+
1 PIANO SPECCHIO
1 MIRROR SHELF



*modelli statici 1860 mm
static model 1860 mm

670 X 640 X 1910 mm

4102

							
NP		-15 / -25 °C +2 / +10 °C	2	0,40	370	120 - 135	4.250,00 €
CB		+5 / -25 °C +10 / -5 °C	1	0,50	360	125 - 140	4.690,00 €

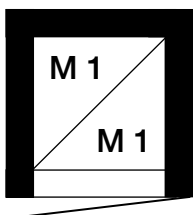

1 LATO ESPOSITIVO
1 GLAZED SIDE

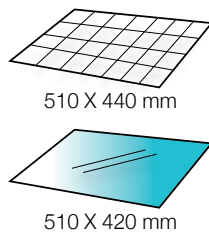



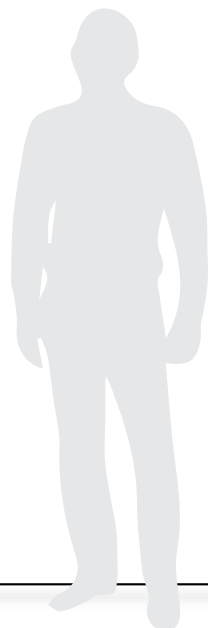



2+2 GRIGLIE
2+2 GRIDS
OR
2+2 PIANI VETRO
2+2 GLASS SHELVES



5100

760 X 760 X 1910 mm

							
P	+2 / +10 °C	1	0,28	530	138 - 156	3.470,00 €	
NFP	+10 / -5 °C	1	0,42	510	140 - 158	4.120,00 €	
NFN	+5 / -25 °C	1	0,55	510	150 - 168	4.470,00 €	

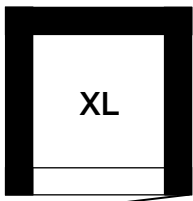

1 LATO ESPOSITIVO
1 GLAZED SIDE

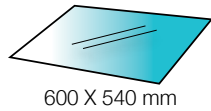
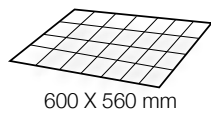







5 GRIGLIE
5 GRIDS
or
5 PIANI VETRO
5 GLASS SHELVES



*modelli statici 1860 mm
static model 1860 mm

5200

760 X 760 X 1910 mm

							
P	+2 / +10 °C	1	0,28	540	150 - 168	3.770,00 €	
NFP	+10 / -5 °C	1	0,50	530	160 - 178	4.470,00 €	
NFN	+5 / -25 °C	1	0,68	530	164 - 182	5.110,00 €	

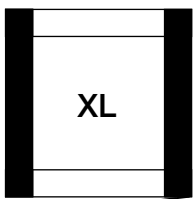

2 LATI ESPOSITIVI
2 GLAZED SIDES

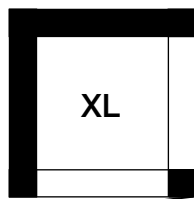

2 LATI ESPOSITIVI
2 GLAZED SIDES

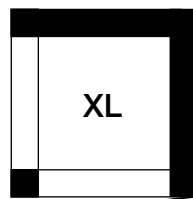

2 LATI ESPOSITIVI
2 GLAZED SIDES

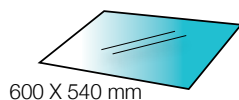
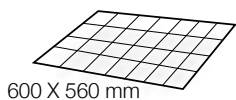

5 GRIGLIE 5 GRIDS or **5 PIANI VETRO 5 GLASS SHELVES**



*modelli statici 1860 mm
static model 1860 mm

760 X 760 X 1910 mm

5300

STATIC	NO FROST	LOCK	RECYCLE	KW	LT	KG	€
P	+2 / +10 °C	1	0,45	550	160 - 178	3.880,00 €	
NFP	+10 / -5 °C	1	0,50	530	170 - 188	4.490,00 €	
NFN	+5 / -25 °C	1	0,68	530	175 - 193	5.510,00 €	

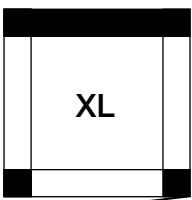

3 LATI ESPOSITIVI
3 GLAZED SIDES

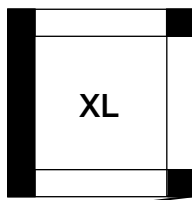

3 LATI ESPOSITIVI
3 GLAZED SIDES

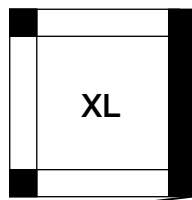

3 LATI ESPOSITIVI
3 GLAZED SIDES

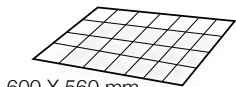

600 X 560 mm

5 GRIGLIE 5 GRIDS or **5 PIANI VETRO 5 GLASS SHELVES**

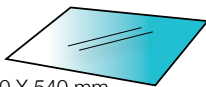

600 X 540 mm



SILVER



BRONZE

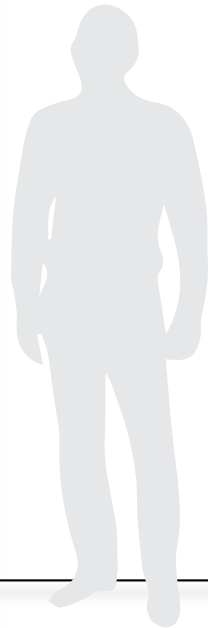

*modelli statici 1860 mm
static model 1860 mm

760 X 760 X 1910 mm

5400

STATIC	NO FROST	LOCK	RECYCLE	KW	LT	KG	€
P	+2 / +10 °C	1	0,45	560	170 - 188	3.970,00 €	
NFP	+10 / -5 °C	1	0,50	540	180 - 198	4.580,00 €	
NFN	+5 / -25 °C	1	0,70	540	185 - 203	5.960,00 €	

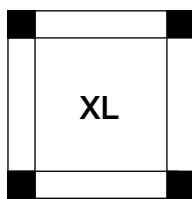

4 LATI ESPOSITIVI
4 GLAZED SIDES

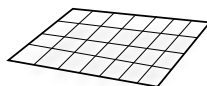

600 X 560 mm

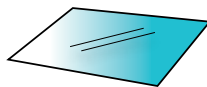

600 X 540 mm

5 GRIGLIE
5 GRIDS
or
5 PIANI VETRO
5 GLASS SHELVES



SILVER





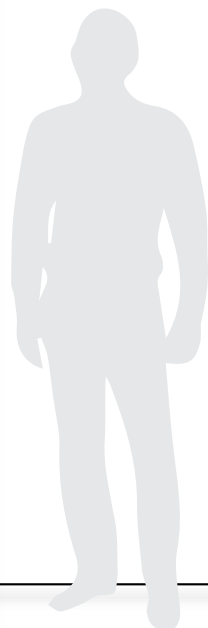



BRONZE



*modelli statici 1860 mm
static model 1860 mm

5401

760 X 760 X 1910 mm

							
P		+2 / +10 °C	1	0,50	560	180 - 198	4.340,00 €
NFP		+10 / -5 °C	1	0,55	540	190 - 208	4.940,00 €
NFN		+5 / -25 °C	1	0,75	540	195 - 213	6.220,00 €

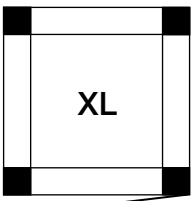

4 LATI ESPOSITIVI
4 GLAZED SIDES

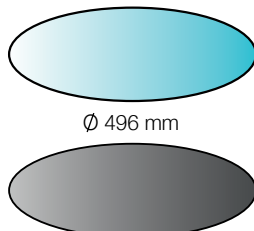

6 PIANI VETRO
6 GLASS SHELVES
+
1 PIANO SPECCHIO
1 MIRROR SHELF









SILVER

BRONZE



5102

760 X 760 X 1910 mm

							
CB		+5 / -25 °C +10 / -5 °C	1	0,50	480	152 - 167	5.410,00 €

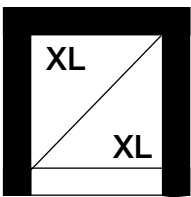

1 LATO ESPOSITIVO
1 GLAZED SIDE

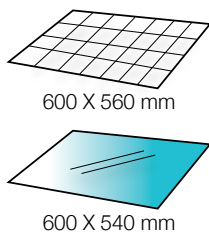

2+2 GRIGLIE
2+2 GRIDS
OR
2+2 PIANI VETRO
2+2 GLASS SHELVES



SILVER







BRONZE



*modelli statici 1860 mm
static model 1860 mm

900 X 640 X 1910 mm

9100

							
P	+2 / +10 °C	1	0,28	555	138 - 156	3.410,00 €	
NT	-15 / -25 °C	1	0,45	555	140 - 158	3.900,00 €	
NFP	+10 / -5 °C	1	0,42	535	140 - 158	3.840,00 €	
NFN	+5 / -25 °C	1	0,55	535	142 - 160	4.410,00 €	



1 LATO ESPOSITIVO
1 GLAZED SIDE

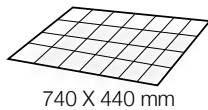

740 X 440 mm

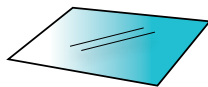

740 X 420 mm

5 GRIGLIE
5 GRIDS
or
5 PIANI VETRO
5 GLASS SHELVES



SILVER





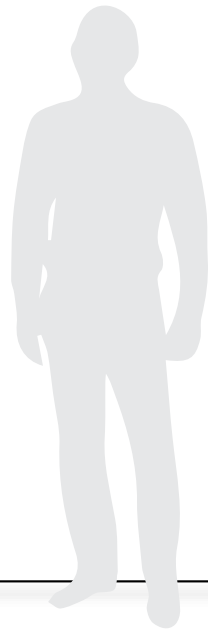



BRONZE



*modelli statici 1860 mm
static model 1860 mm

900 X 640 X 1910 mm

9200

							
P	+2 / +10 °C	1	0,28	590	150 - 168	3.880,00 €	
NT	-15 / -25 °C	1	0,60	590	152 - 170	4.650,00 €	
NFP	+10 / -5 °C	1	0,50	570	152 - 170	4.360,00 €	
NFN	+5 / -25 °C	1	0,68	570	154 - 172	5.330,00 €	

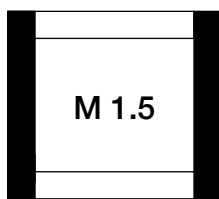

2 LATI ESPOSITIVI
2 GLAZED SIDES

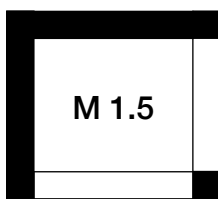

2 LATI ESPOSITIVI
2 GLAZED SIDES

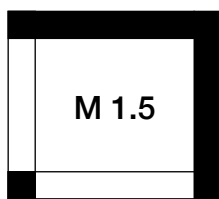

2 LATI ESPOSITIVI
2 GLAZED SIDES

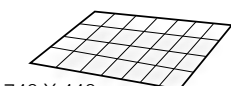

740 X 440 mm

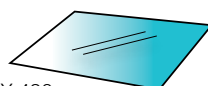

740 X 420 mm

5 GRIGLIE 5 GRIDS or **5 PIANI VETRO 5 GLASS SHELVES**



SILVER



BRONZE

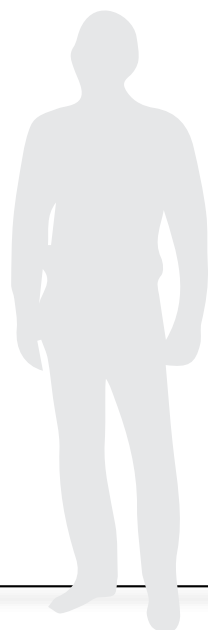

*modelli statici 1860 mm
static model 1860 mm

9300

900 X 640 X 1910 mm

Icon	Temp	Vol	Power	Capacity	Weight	Price
P	+2 / +10 °C	1	0,45	620	153 - 170	3.940,00 €
NT	-15 / -25 °C	1	0,70	620	155 - 173	5.060,00 €
NFP	+10 / -5 °C	1	0,50	590	157 - 175	4.420,00 €
NFN	+5 / -25 °C	1	0,68	590	159 - 177	5.810,00 €

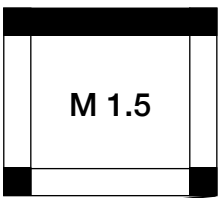

**3 LATI ESPOSITIVI
3 GLAZED SIDES**

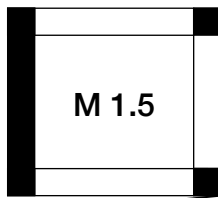

**3 LATI ESPOSITIVI
3 GLAZED SIDES**

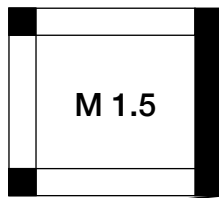

**3 LATI ESPOSITIVI
3 GLAZED SIDES**

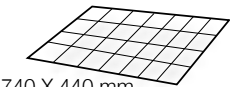

740 X 440 mm

5 GRIGLIE 5 GRIDS or 5 PIANI VETRO 5 GLASS SHELVES

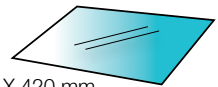

740 X 420 mm



SILVER



BRONZE



*modelli statici 1860 mm static model 1860 mm

9400

900 X 640 X 1910 mm

Icon	Temp	Vol	Power	Capacity	Weight	Price
P	+2 / +10 °C	1	0,45	630	166 - 184	4.020,00 €
NT	-15 / -25 °C	1	0,75	630	168 - 186	5.230,00 €
NFP	+10 / -5 °C	1	0,50	595	166 - 184	4.480,00 €
NFN	+5 / -25 °C	1	0,70	595	170 - 188	5.960,00 €

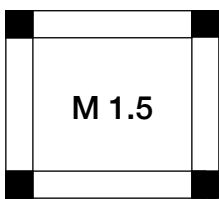

**4 LATI ESPOSITIVI
4 GLAZED SIDES**

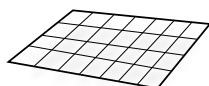

740 X 440 mm

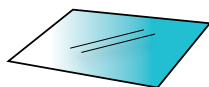

740 X 420 mm

**5 GRIGLIE
5 GRIDS
or
5 PIANI VETRO
5 GLASS SHELVES**



SILVER











BRONZE



*modelli statici 1860 mm static model 1860 mm

900 X 640 X 1910 mm

9102

	 						
NP	-15 / -25 °C +2 / +10 °C	2	0,40	530	142 - 157	5.500,00 €	
CB	+5 / -25 °C +10 / -5 °C	1	0,50	520	145 - 160	5.920,00 €	

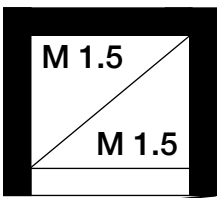

1 LATO ESPOSITIVO
1 GLAZED SIDE

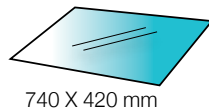
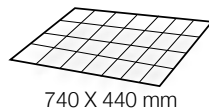

2+2 GRIGLIE
2+2 GRIDS
or
2+2 PIANI VETRO
2+2 GLASS SHELVES



SILVER





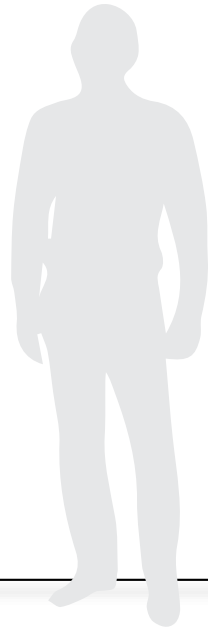





BRONZE



900 X 640 X 1910 mm

9420

	 						
NP	-15 / -25 °C +2 / +10 °C	2	0,50	520	168 - 186	5.720,00 €	
NT	-15 / -25 °C	2	0,75	520	168 - 186	6.510,00 €	
NFN	+5 / -25 °C	2	1,20	550	200 - 220	7.080,00 €	
CB	+5 / -25 °C +10 / -5 °C	2	0,80	550	195 - 215	6.070,00 €	

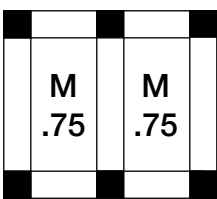

4 LATI ESPOSITIVI
4 GLAZED SIDES

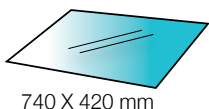
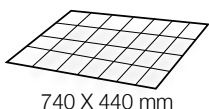

5+5 GRIGLIE
5+5 GRIDS
or
5+5 PIANI VETRO
5+5 GLASS SHELVES



SILVER



BRONZE

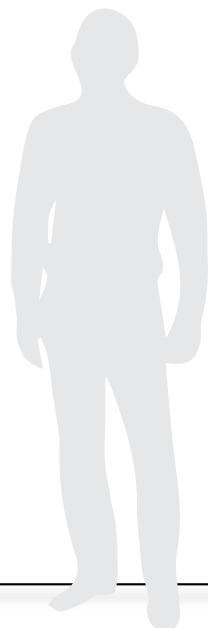

9120

900 X 640 X 1910 mm

STATIC	NO FROST	TEMPERATURE	DOOR	KW	LT	KG	€
NP	-15 / -25 °C +2 / +10 °C	2	0,50	520	168 - 186	4.780,00 €	
NT	-15 / -25 °C	2	0,75	520	168 - 186	5.110,00 €	
NFN	+5 / -25 °C	2	0,60	550	170 - 190	5.580,00 €	
CB	+5 / -25 °C +10 / -5 °C	2	0,52	550	164 - 184	5.150,00 €	

*modelli statici 1860 mm / static model 1860 mm

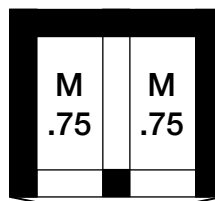

1 LATI ESPOSITIVO
1 GLAZED SIDE



SILVER

BRONZE

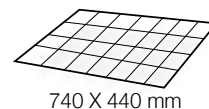

740 X 440 mm

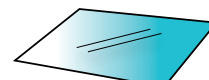

740 X 420 mm

5+5 GRIGLIE
5+5 GRIDS
or
5+5 PIANI VETRO
5+5 GLASS SHELVES

9220

900 X 640 X 1910 mm

STATIC	NO FROST	TEMPERATURE	DOOR	KW	LT	KG	€
NP	-15 / -25 °C +2 / +10 °C	2	0,50	520	168 - 186	5.000,00 €	
NT	-15 / -25 °C	2	0,75	520	168 - 186	5.300,00 €	
NFN	+5 / -25 °C	2	0,60	550	180 - 200	5.840,00 €	
CB	+5 / -25 °C +10 / -5 °C	2	0,52	550	174 - 194	5.420,00 €	

*modelli statici 1860 mm / static model 1860 mm

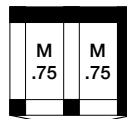
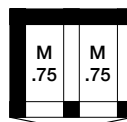
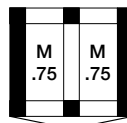

2 LATI ESPOSITIVI
2 GLAZED SIDES



SILVER

BRONZE

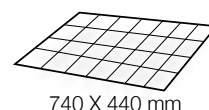

740 X 440 mm

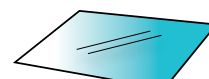

740 X 420 mm

5+5 GRIGLIE
5+5 GRIDS
or
5+5 PIANI VETRO
5+5 GLASS SHELVES

9320

900 X 640 X 1910 (1240 TOP) mm

STATIC	NO FROST	TEMPERATURE	DOOR	KW	LT	KG	€
NP	-15 / -25 °C +2 / +10 °C	2	0,50	520	168 - 186	5.280,00 €	
NT	-15 / -25 °C	2	0,75	520	168 - 186	5.930,00 €	
NFN	+5 / -25 °C	2	1,20	550	180 - 200	6.450,00 €	
CB	+5 / -25 °C +10 / -5 °C	2	0,80	550	174 - 194	5.800,00 €	

*modelli statici 1860 mm / static model 1860 mm

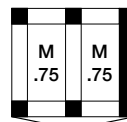
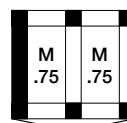
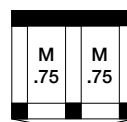

3 LATI ESPOSITIVI
3 GLAZED SIDES



SILVER

BRONZE

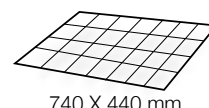

740 X 440 mm

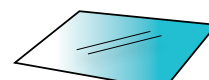

740 X 420 mm

5+5 GRIGLIE
5+5 GRIDS
or
5+5 PIANI VETRO
5+5 GLASS SHELVES

1320 X 640 X 1910 mm

7100

STATIC	NO Frost	Key	Recycling	KW	LT	KG	€
P	+2 / +10 °C	1	0,52	855	180 - 217	4.220,00 €	
NT	-15 / -25 °C	1	1,00	855	185 - 222	4.540,00 €	
NFP	+10 / -5 °C	1	0,50	810	192 - 229	4.940,00 €	
NFN	+5 / -25 °C	1	1,00	810	202 - 239	5.320,00 €	

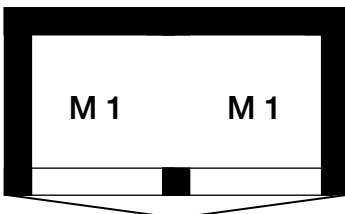

1 LATO ESPOSITIVO
1 GLAZED SIDE



SILVER



BRONZE

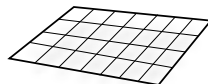

1150 X 440 mm

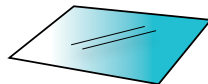

1150 X 420 mm

5 GRIGLIE
5 GRIDS
or
3 PIANI VETRO
3 GLASS SHELVES



*modelli statici 1860 mm
static model 1860 mm

1320 X 640 X 1910 mm

7200

STATIC	NO Frost	Key	Recycling	KW	LT	KG	€
P	+2 / +10 °C	1	0,56	905	203 - 240	4.580,00 €	
NT	-15 / -25 °C	1	1,00	905	210 - 247	5.170,00 €	
NFP	+10 / -5 °C	1	0,60	855	215 - 252	5.240,00 €	
NFN	+5 / -25 °C	1	1,20	855	225 - 262	6.230,00 €	

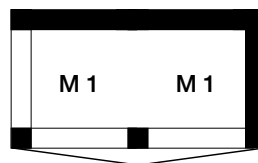
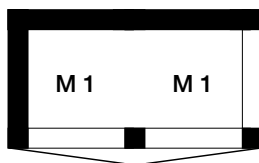
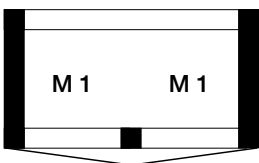

2 LATI ESPOSITIVI
2 GLAZED SIDES



SILVER



BRONZE

1150 X 440 mm

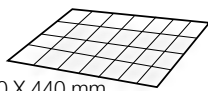

1150 X 420 mm

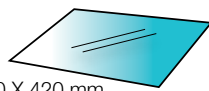

5 GRIGLIE 5 GRIDS or **3 PIANI VETRO 3 GLASS SHELVES**



*modelli statici 1860 mm
static model 1860 mm

7300

1320 X 640 X 1910 mm

STATIC	NO Frost	Thermometer	Energy	KW	LT	KG	€
P	+2 / +10 °C	1	0,80	935	235 - 272	4.620,00 €	
NT	-15 / -25 °C	1	1,20	935	245 - 282	5.550,00 €	
NFP	+10 / -5 °C	1	0,68	880	238 - 275	5.320,00 €	
NFN	+5 / -25 °C	1	1,20	880	248 - 285	6.880,00 €	

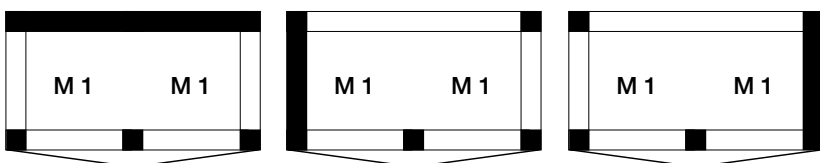

3 LATI ESPOSITIVI
3 GLAZED SIDES



SILVER



BRONZE

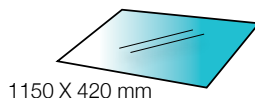
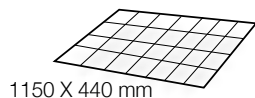

5 GRIGLIE 5 GRIDS or 3 PIANI VETRO 3 GLASS SHELVES



*modelli statici 1860 mm
static model 1860 mm

7400

1320 X 640 X 1910 mm

STATIC	NO Frost	Thermometer	Energy	KW	LT	KG	€
P	+2 / +10 °C	1	0,80	935	235 - 272	4.650,00 €	
NT	-15 / -25 °C	1	1,20	935	245 - 282	5.820,00 €	
NFP	+10 / -5 °C	1	0,68	880	238 - 275	5.370,00 €	
NFN	+5 / -25 °C	1	1,20	880	258 - 297	6.880,00 €	

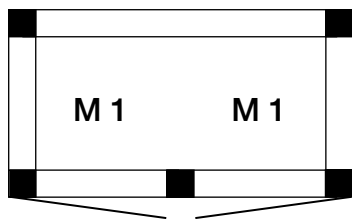

4 LATI ESPOSITIVI
4 GLAZED SIDES



SILVER



BRONZE

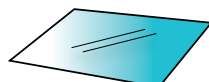
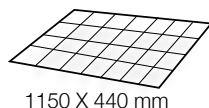







5 GRIGLIE
5 GRIDS
or
3 PIANI VETRO
3 GLASS SHELVES



*modelli statici 1860 mm
static model 1860 mm

1320 X 640 X 1910 mm

7401

							
P	+2 / +10 °C	1	0,80	935	256 - 291	4.930,00 €	
NFP	+10 / -5 °C	1	0,68	880	248 - 287	5.730,00 €	
NFN	+5 / -25 °C	1	1,20	880	268 - 305	8.010,00 €	

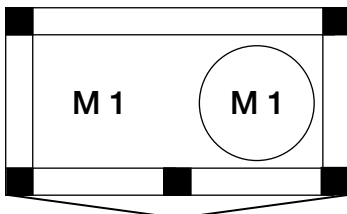

4 LATI ESPOSITIVI
4 GLAZED SIDES



SILVER



BRONZE

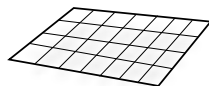

1150 X 440 mm

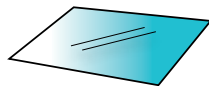

1150 X 420 mm

5 GRIGLIE
5 GRIDS
OR
5 PIANI VETRO
5 GLASS SHELVES

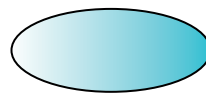

6 PIANI VETRO
6 GLASS SHELVES
+
1 PIANO SPECCHIO
1 MIRROR SHELF



*modelli statici 1860 mm
static model 1860 mm

1320 X 760 X 1910 mm

7401 XL

							
P	+2 / +10 °C	1	0,80	1132	256 - 291	6.020,00 €	
NFP	+10 / -5 °C	1	0,68	1077	248 - 287	6.960,00 €	
NFN	+5 / -25 °C	1	1,20	1077	268 - 305	9.800,00 €	

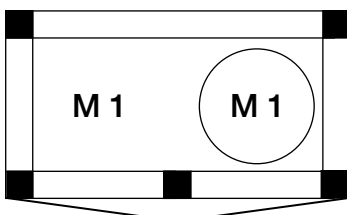

4 LATI ESPOSITIVI
4 GLAZED SIDES



SILVER



BRONZE

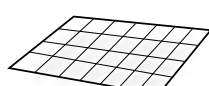

510 X 560 mm

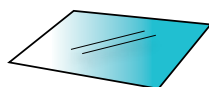

510 X 540 mm

5 GRIGLIE
5 GRIDS
OR
5 PIANI VETRO
5 GLASS SHELVES

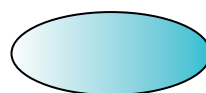

6 PIANI VETRO
6 GLASS SHELVES
+
1 PIANO SPECCHIO
1 MIRROR SHELF



*modelli statici 1860 mm
static model 1860 mm

7100 XL

1320 X 760 X 1910 mm

P	+2 / +10 °C	1	0,52	1052	180 - 217	5.160,00 €	
NFP	+10 / -5 °C	1	0,50	1007	202 - 239	5.810,00 €	
NFN	+5 / -25 °C	1	1,00	1007	202 - 239	6.330,00 €	

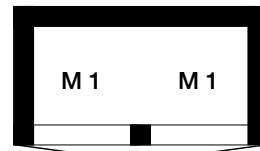

1 LATO ESPOSITIVO
1 GLAZED SIDE

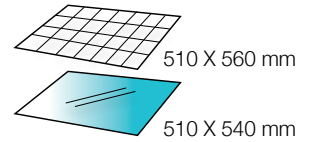

5+5 GRIGLIE
5+5 GRIDS
OR
5+5 PIANI VETRO
5+5 GLASS SHELVES

*modelli statici 1860 mm / static model 1860 mm

7200 XL

1320 X 760 X 1910 mm

P	+2 / +10 °C	1	0,56	1102	203 - 240	5.580,00 €	
NFP	+10 / -5 °C	1	0,60	1052	215 - 252	6.390,00 €	
NFN	+5 / -25 °C	1	1,20	1052	225 - 262	7.630,00 €	

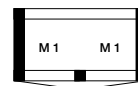

2 LATI ESPOSITIVI **2 GLAZED SIDES**

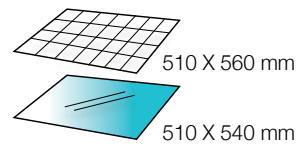

5+5 GRIGLIE
5+5 GRIDS
5+5 PIANI VETRO
5+5 GLASS SHELVES



*modelli statici 1860 mm / static model 1860 mm

7300 XL

1320 X 760 X 1910 mm

P	+2 / +10 °C	1	0,80	1132	235 - 272	5.640,00 €	
NFP	+10 / -5 °C	1	0,68	1077	238 - 275	6.500,00 €	
NFN	+5 / -25 °C	1	1,20	1077	248 - 285	8.430,00 €	

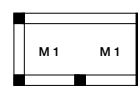
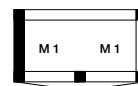

3 LATI ESPOSITIVI **3 GLAZED SIDES**

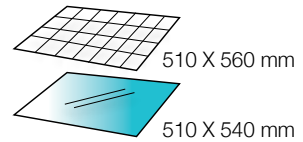

5+5 GRIGLIE
5+5 GRIDS
5+5 PIANI VETRO
5+5 GLASS SHELVES



*modelli statici 1860 mm / static model 1860 mm

7400 XL

1320 X 760 X 1910 mm

P	+2 / +10 °C	1	0,80	1132	235 - 272	5.700,00 €	
NFP	+10 / -5 °C	1	0,68	1077	238 - 275	6.570,00 €	
NFN	+5 / -25 °C	1	1,20	1077	258 - 297	8.430,00 €	

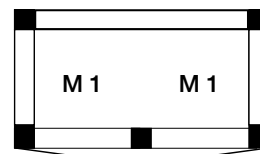

1 LATO ESPOSITIVO
1 GLAZED SIDE

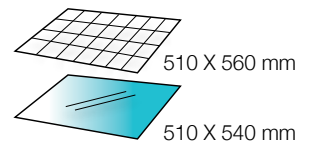

5+5 GRIGLIE
5+5 GRIDS
OR
5+5 PIANI VETRO
5+5 GLASS SHELVES

*modelli statici 1860 mm / static model 1860 mm

1320 X 640 X 1910 mm

8100

STATIC NO FROST	TEMPERATURE	DOORS	KW	LT	KG	€
P	+2 / +10 °C	2	0,52	855	210 - 247	4.780,00 €
NT	-15 / -25 °C	2	0,80	855	220 - 257	5.150,00 €
NP	-15 / -25 °C +2 / +10 °C	2	0,60	855	215 - 252	5.110,00 €
NFP	+10 / -5 °C	2	0,80	810	222 - 259	5.400,00 €
NFN	+5 / -25 °C	2	1,00	810	232 - 269	6.150,00 €
CB	+5 / -25 °C +10 / -5 °C	2	0,90	810	227 - 264	5.770,00 €

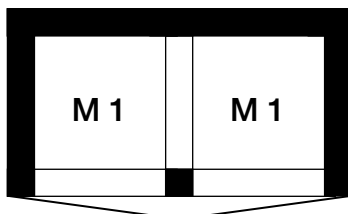

1 LATO ESPOSITIVO
1 GLAZED SIDE



SILVER



BRONZE

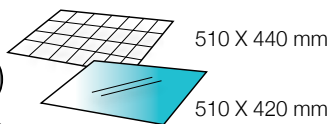

5+5 GRIGLIE
5+5 GRIDS
or
5+5 PIANI VETRO
5+5 GLASS SHELVES



*modelli statici 1860 mm
static model 1860 mm

1320 X 640 X 1910 mm

8200

STATIC NO FROST	TEMPERATURE	DOORS	KW	LT	KG	€
P	+2 / +10 °C	2	0,56	905	233 - 270	5.090,00 €
NT	-15 / -25 °C	2	1,10	905	243 - 280	5.960,00 €
NP	-15 / -25 °C +2 / +10 °C	2	0,80	905	238 - 275	5.450,00 €
NFP	+10 / -5 °C	2	0,84	855	245 - 282	5.860,00 €
NFN	+5 / -25 °C	2	1,30	855	255 - 292	7.350,00 €
CB	+5 / -25 °C +10 / -5 °C	2	1,07	855	250 - 287	6.570,00 €

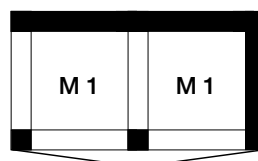
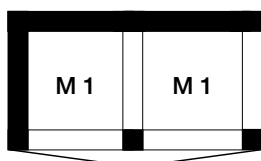
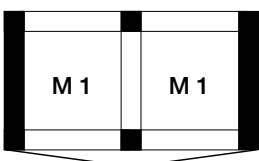

2 LATI ESPOSITIVI **2 GLAZED SIDES**



SILVER



BRONZE

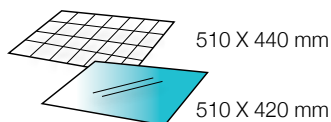

5+5 GRIGLIE
5+5 GRIDS
5+5 PIANI VETRO
5+5 GLASS SHELVES



*modelli statici 1860 mm
static model 1860 mm

8300

1320 X 640 X 1910 mm

STATIC NO FROST	TEMPERATURE	DOORS	KW	LITERS	KG	PRICE
P	+2 / +10 °C	2	0,80	915	255 - 292	5.250,00 €
NT	-15 / -25 °C	2	1,50	915	265 - 302	6.250,00 €
NP	-15 / -25 °C +2 / +10 °C	2	1,10	915	260 - 297	5.960,00 €
NFP	+10 / -5 °C	2	1,00	875	258 - 295	6.110,00 €
NFN	+5 / -25 °C	2	1,36	875	268 - 305	8.150,00 €
CB	+5 / -25 °C +10 / -5 °C	2	1,18	875	263 - 300	7.090,00 €

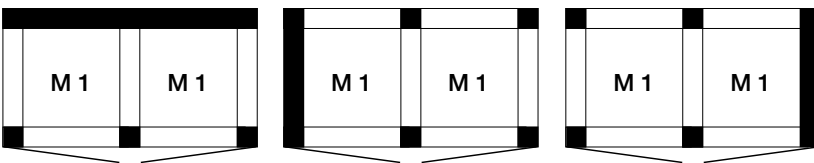

3 LATI ESPOSITIVI 3 GLAZED SIDES

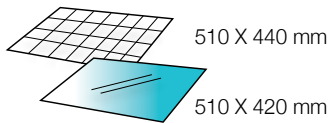

5+5 GRIGLIE
5+5 GRIDS
5+5 PIANI VETRO
5+5 GLASS SHELVES



*modelli statici 1860 mm
static model 1860 mm

8400

1320 X 640 X 1910 mm

STATIC NO FROST	TEMPERATURE	DOORS	KW	LITERS	KG	PRICE
P	+2 / +10 °C	2	0,80	935	278 - 315	5.240,00 €
NT	-15 / -25 °C	2	1,50	935	288 - 325	6.350,00 €
NP	-15 / -25 °C +2 / +10 °C	2	1,10	935	283 - 320	6.130,00 €
NFP	+10 / -5 °C	2	1,00	880	262 - 299	6.180,00 €
NFN	+5 / -25 °C	2	1,36	880	272 - 309	8.350,00 €
CB	+5 / -25 °C +10 / -5 °C	2	1,18	880	267 - 304	7.260,00 €

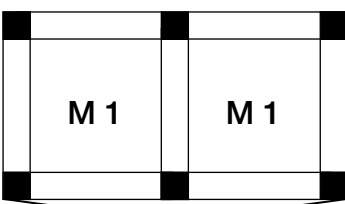

4 LATI ESPOSITIVI
4 GLAZED SIDES

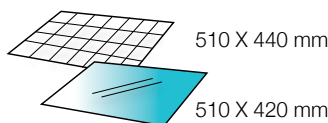

5+5 GRIGLIE
5+5 GRIDS
OR
5+5 PIANI VETRO
5+5 GLASS SHELVES



*modelli statici 1860 mm
static model 1860 mm

1320 X 640 X 1910 mm

8401

STATIC NO FROST	TEMPERATURE	DOORS	KW	LT	KG	€
P	+2 / +10 °C	2	0,80	935	284 - 321	6.120,00 €
NP	-15 / -25 °C +2 / +10 °C	2	1,10	935	298 - 335	6.510,00 €
NFP	+10 / -5 °C	2	1,00	880	278 - 315	6.660,00 €
NFN	+5 / -25 °C	2	1,36	880	288 - 325	9.380,00 €
CB	+5 / -25 °C +10 / -5 °C	2	1,18	880	283 - 320	7.990,00 €

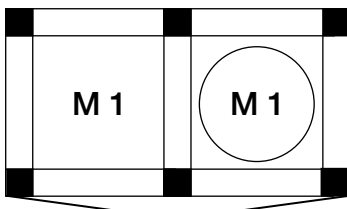

4 LATI ESPOSITIVI 4 GLAZED SIDES



SILVER



BRONZE

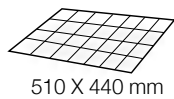

510 X 440 mm

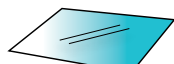

510 X 420 mm

**5 GRIGLIE
5 GRIDS
OR
5 PIANI VETRO
5 GLASS SHELVES**

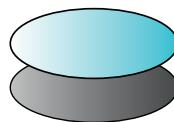

**6 PIANI VETRO
6 GLASS SHELVES
+
1 PIANO SPECCHIO
1 MIRROR SHELF**



*modelli statici 1860 mm
static model 1860 mm

1320 X 760 X 1910 mm

10401

STATIC NO FROST	TEMPERATURE	DOORS	KW	LT	KG	€
P	+2 / +10 °C	2	0,90	1260	315 - 345	7.750,00 €
NFP	+10 / -5 °C	2	1,00	1160	320 - 350	8.830,00 €
NFN	+5 / -25 °C	2	1,40	1160	330 - 360	11.170,00 €
CB	+5 / -25 °C +10 / -5 °C	2	1,20	1160	325 - 355	10.240,00 €

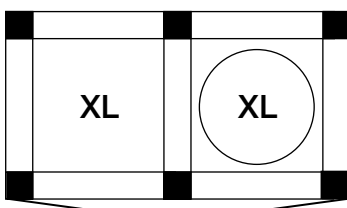

4 LATI ESPOSITIVI 4 GLAZED SIDES



SILVER



BRONZE

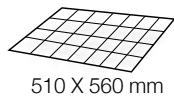

510 X 560 mm

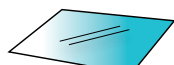

510 X 540 mm

**5 GRIGLIE
5 GRIDS
OR
5 PIANI VETRO
5 GLASS SHELVES**

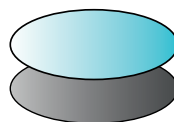

**6 PIANI VETRO
6 GLASS SHELVES
+
1 PIANO SPECCHIO
1 MIRROR SHELF**



*modelli statici 1860 mm
static model 1860 mm

glassy line

10100

1500 X 760 X 1910 mm

STATIC NO FROST	TEMPERATURE	DOORS	KW	LT	KG	€
P	+2 / +10 °C	2	0,55	1110	250 - 280	6.080,00 €
NFP	+10 / -5 °C	2	0,84	1065	252 - 282	7.260,00 €
NFN	+5 / -25 °C	2	1,10	1065	256 - 286	7.860,00 €
CB	+5 / -25 °C +10 / -5 °C	2	0,97	1065	254 - 284	7.740,00 €

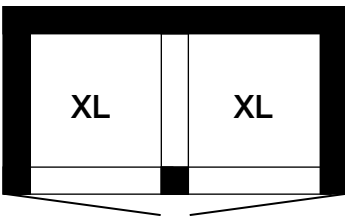

1 LATO ESPOSITIVO
1 GLAZED SIDE



SILVER
BRONZE

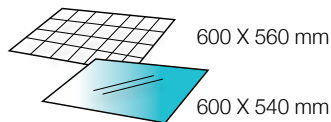

5+5 GRIGLIE
5+5 GRIDS
OR
5+5 PIANI VETRO
5+5 GLASS SHELVES



*modelli statici 1860 mm
static model 1860 mm

10200

1500 X 760 X 1910 mm

STATIC NO FROST	TEMPERATURE	DOORS	KW	LT	KG	€
P	+2 / +10 °C	2	0,56	1180	275 - 305	6.590,00 €
NFP	+10 / -5 °C	2	1,00	1135	280 - 310	7.860,00 €
NFN	+5 / -25 °C	2	1,36	1135	290 - 320	9.380,00 €
CB	+5 / -25 °C +10 / -5 °C	2	1,18	1135	285 - 315	8.440,00 €

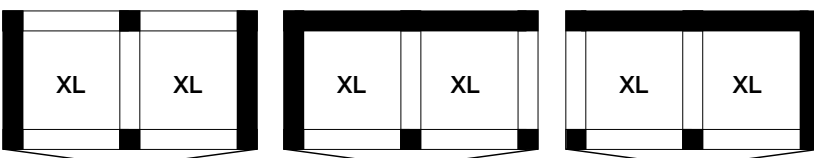

2 LATI ESPOSITIVI
2 GLAZED SIDES



SILVER
BRONZE

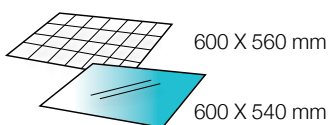

5+5 GRIGLIE
5+5 GRIDS
OR
5+5 PIANI VETRO
5+5 GLASS SHELVES



*modelli statici 1860 mm
static model 1860 mm

1500 X 760 X 1910 mm

10300

STATIC NO FROST	TEMPERATURE	DOORS	KW	LT	KG	€
P	+2 / +10 °C	2	0,90	1200	280 - 310	7.030,00 €
NFP	+10 / -5 °C	2	1,00	1150	290 - 320	8.000,00 €
NFN	+5 / -25 °C	2	1,36	1150	300 - 330	10.210,00 €
CB	+5 / -25 °C +10 / -5 °C	2	1,18	1150	295 - 325	8.850,00 €

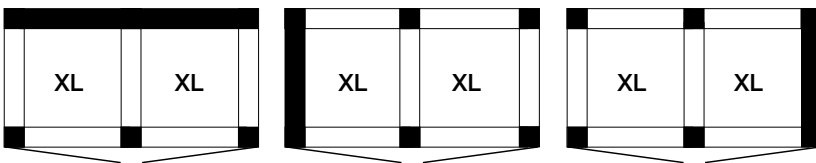

3 LATI ESPOSITIVI
3 GLAZED SIDES



SILVER



BRONZE

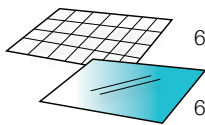

600 X 560 mm

600 X 540 mm

5+5 GRIGLIE
5+5 GRIDS
or
5+5 PIANI VETRO
5+5 GLASS SHELVES



*modelli statici 1860 mm
static model 1860 mm

1500 X 760 X 1910 mm

10400

STATIC NO FROST	TEMPERATURE	DOORS	KW	LT	KG	€
P	+2 / +10 °C	2	0,90	1210	305 - 335	7.110,00 €
NFP	+10 / -5 °C	2	1,00	1160	310 - 340	8.100,00 €
NFN	+5 / -25 °C	2	1,40	1160	320 - 350	10.560,00 €
CB	+5 / -25 °C +10 / -5 °C	2	1,20	1160	315 - 345	9.630,00 €

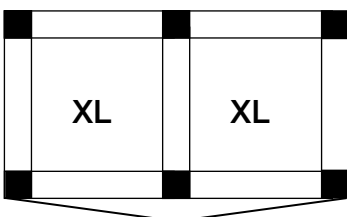

4 LATI ESPOSITIVI
4 GLAZED SIDES



SILVER



BRONZE

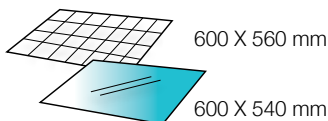

600 X 560 mm

600 X 540 mm







5+5 GRIGLIE
5+5 GRIDS
or
5+5 PIANI VETRO
5+5 GLASS SHELVES



*modelli statici 1860 mm
static model 1860 mm

1310

1550 X 640 X 1910 mm

						€
P	+2 / +10 °C	2	0,50	915	252 - 294	6.060,00 €
NT	-15 / -25 °C	2	0,90	915	262 - 304	6.600,00 €
NP	-15 / -25 °C +2 / +10 °C	2	0,70	915	257 - 299	6.780,00 €
NFP	+10 / -5 °C	2	0,90	875	264 - 306	6.930,00 €
NFN	+5 / -25 °C	2	1,50	875	274 - 316	7.930,00 €
CB	+5 / -25 °C +10 / -5 °C	2	1,20	875	269 - 311	7.470,00 €

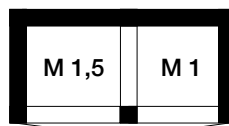

**1 LATO ESPOSITIVO
1 GLAZED SIDE**

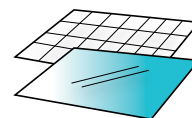

**5+5 GRIGLIE
5+5 GRIDS
OR
5+5 PIANI VETRO
5+5 GLASS SHELVES**



SILVER









BRONZE

*modelli statici 1860 mm
static model 1860 mm

1320

1550 X 640 X 1910 mm

						€
P	+2 / +10 °C	2	0,50	915	275 - 317	6.540,00 €
NT	-15 / -25 °C	2	0,90	915	285 - 327	8.000,00 €
NP	-15 / -25 °C +2 / +10 °C	2	0,70	915	287 - 322	7.160,00 €
NFP	+10 / -5 °C	2	0,90	875	277 - 319	7.560,00 €
NFN	+5 / -25 °C	2	1,50	875	287 - 329	9.480,00 €
CB	+5 / -25 °C +10 / -5 °C	2	1,20	875	282 - 324	8.490,00 €

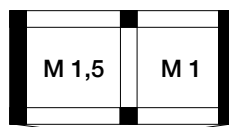

**2 LATI ESPOSITIVI
2 GLAZED SIDES**

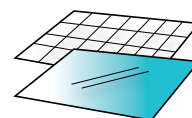

**5+5 GRIGLIE
5+5 GRIDS
OR
5+5 PIANI VETRO
5+5 GLASS SHELVES**



SILVER









BRONZE

*modelli statici 1860 mm
static model 1860 mm

1330

1550 X 640 X 1910 mm

						€
P	+2 / +10 °C	2	0,90	915	290 - 332	6.740,00 €
NT	-15 / -25 °C	2	1,50	915	300 - 342	8.590,00 €
NP	-15 / -25 °C +2 / +10 °C	2	1,20	915	295 - 337	7.530,00 €
NFP	+10 / -5 °C	2	0,90	875	298 - 340	7.960,00 €
NFN	+5 / -25 °C	2	1,50	875	308 - 350	10.200,00 €
CB	+5 / -25 °C +10 / -5 °C	2	1,20	875	303 - 345	8.860,00 €

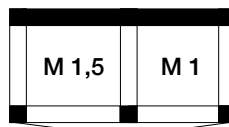

**3 LATI ESPOSITIVI
3 GLAZED SIDES**

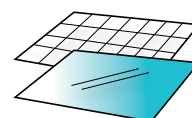

**5+5 GRIGLIE
5+5 GRIDS
OR
5+5 PIANI VETRO
5+5 GLASS SHELVES**



SILVER











BRONZE

*modelli statici 1860 mm
static model 1860 mm

1550 X 640 X 1910 mm

1340



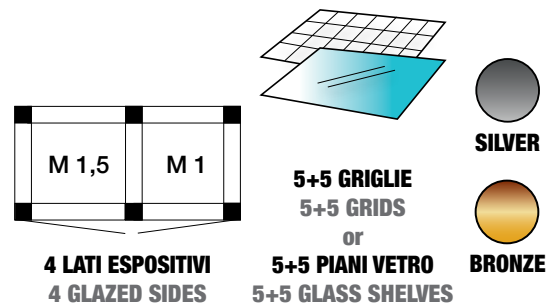





 						
P	+2 / +10 °C	2	0,90	915	319 - 361	6.920,00 €
NT	-15 / -25 °C	2	1,50	915	329 - 371	8.870,00 €
NP	-15 / -25 °C +2 / +10 °C	2	1,20	915	324 - 366	7.720,00 €
NFP	+10 / -5 °C	2	0,90	875	319 - 362	8.020,00 €
NFN	+5 / -25 °C	2	1,50	875	329 - 372	10.720,00 €
CB	+5 / -25 °C +10 / -5 °C	2	1,20	875	324 - 367	9.180,00 €



*modelli statici 1860 mm
static model 1860 mm

1550 X 640 X 1910 mm

1341

 						
P	+2 / +10 °C	2	0,90	915	327 - 369	7.930,00 €
NP	-15 / -25 °C +2 / +10 °C	2	1,20	915	332 - 374	8.750,00 €
NFP	+10 / -5 °C	2	0,90	875	327 - 369	8.780,00 €
NFN	+5 / -25 °C	2	1,50	875	337 - 380	12.300,00 €
CB	+5 / -25 °C +10 / -5 °C	2	1,20	875	332 - 374	10.550,00 €

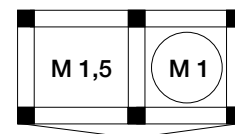

4 LATI ESPOSITIVI
4 GLAZED SIDES

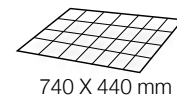

740 X 440 mm

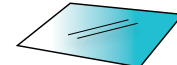

740 X 420 mm

5 GRIGLIE
5 GRIDS
or
5 PIANI VETRO
5 GLASS SHELVES

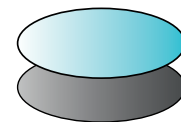

6 PIANI VETRO
6 GLASS SHELVES
+
1 PIANO SPECCHIO
1 MIRROR SHELF



SILVER



BRONZE

*modelli statici 1860 mm
static model 1860 mm

1200

1970 X 640 X 1910 mm

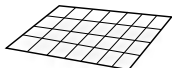

510 X 440 mm

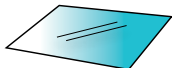

510 X 420 mm

5+5+5 GRIGLIE
5+5+5 GRIDS
OR
5+5+5 PIANI VETRO
5+5+5 GLASS SHELVES

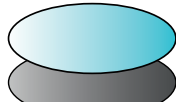

Ø 496 mm

6 PIANI VETRO
6 GLASS SHELVES
+
1 PIANO SPECCHIO
1 MIRROR SHELF



SILVER









BRONZE



*modelli statici 1860 mm
static model 1860 mm

1210

1970 X 640 X 1910 mm



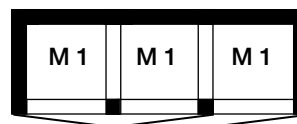



						
P	+2 / +10 °C	3	0,80	1200	320 - 360	6.760,00 €
NT	-15 / -25 °C	3	1,20	1200	320 - 360	7.520,00 €
NP	-15 / -25 °C +2 / +10 °C	3	1,00	1200	320 - 360	7.490,00 €
NFP	+10 / -5 °C	3	1,20	1200	315 - 355	8.150,00 €
NFN	+5 / -25 °C	3	1,50	1200	325 - 365	8.840,00 €
CB	+5 / -25 °C +10 / -5 °C	3	1,35	1200	320 - 360	8.330,00 €



1 LATO ESPOSITIVO
1 GLAZED SIDE

1220

1970 X 640 X 1910 mm

						
P	+2 / +10 °C	3	0,90	1260	350 - 390	7.070,00 €
NT	-15 / -25 °C	3	1,65	1260	345 - 385	8.810,00 €
NP	-15 / -25 °C +2 / +10 °C	3	1,38	1260	350 - 390	8.050,00 €
NFP	+10 / -5 °C	3	1,26	1200	340 - 380	8.710,00 €
NFN	+5 / -25 °C	3	1,95	1200	350 - 390	10.380,00 €
CB	+5 / -25 °C +10 / -5 °C	3	1,60	1200	345 - 385	9.300,00 €

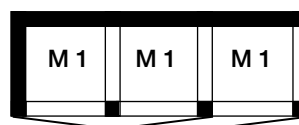
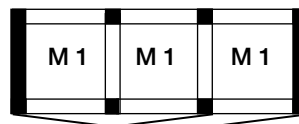



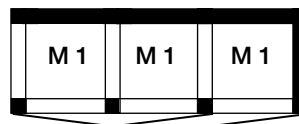





2 LATI ESPOSITIVI
2 GLAZED SIDES



1970 X 640 X 1910 mm

1230



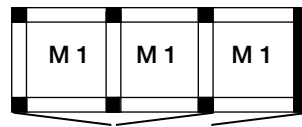
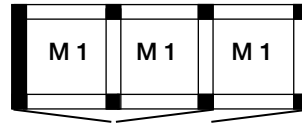
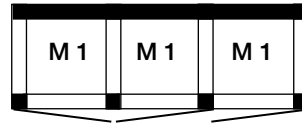





 						
P	+2 / +10 °C	3	1,20	1290	355 - 395	7.090,00 €
NT	-15 / -25 °C	3	2,10	1290	365 - 405	9.060,00 €
NP	-15 / -25 °C +2 / +10 °C	3	1,80	1290	360 - 400	8.110,00 €
NFP	+10 / -5 °C	3	1,50	1230	360 - 400	8.780,00 €
NFN	+5 / -25 °C	3	2,04	1230	370 - 410	11.210,00 €
CB	+5 / -25 °C +10 / -5 °C	3	1,75	1230	365 - 405	9.730,00 €



3 LATI ESPOSITIVI
3 SIDES GLASSES

1970 X 640 X 1910 mm

1240



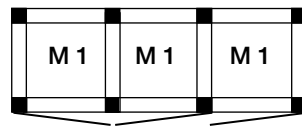





 						
P	+2 / +10 °C	3	1,20	1350	385 - 425	7.160,00 €
NT	-15 / -25 °C	3	2,25	1350	385 - 425	9.180,00 €
NP	-15 / -25 °C +2 / +10 °C	3	1,90	1350	390 - 430	8.270,00 €
NFP	+10 / -5 °C	3	1,50	1240	380 - 420	9.080,00 €
NFN	+5 / -25 °C	3	2,04	1240	390 - 430	11.460,00 €
CB	+5 / -25 °C +10 / -5 °C	3	1,75	1240	385 - 425	10.050,00 €



4 LATI ESPOSITIVI
4 GLAZED SIDES

1970 X 640 X 1910 mm

1241

 						
P	+2 / +10 °C	3	1,20	1350	393 - 433	8.670,00 €
NP	-15 / -25 °C +2 / +10 °C	3	1,90	1350	398 - 438	9.520,00 €
NFP	+10 / -5 °C	3	1,50	1240	388 - 428	9.660,00 €
NFN	+5 / -25 °C	3	2,04	1240	398 - 438	13.220,00 €
CB	+5 / -25 °C +10 / -5 °C	3	1,75	1240	393 - 433	11.430,00 €

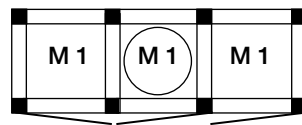

4 LATI ESPOSITIVI
4 GLAZED SIDES

1400

2200 X 640 X 1910 mm

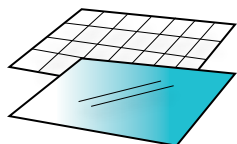

5+5 GRIGLIE
5+5 GRIDS
510 X 420 mm
5 GRIGLIE
5 GRIDS
740 X 440 mm
or
5+5 PIANI VETRO
5+5 GLASS SHELVES
510 X 420 mm
5 PIANI VETRO
5 GLASS SHELVES
740 X 420 mm



SILVER



BRONZE



*modelli statici 1860 mm
static model 1860 mm

1410

2200 X 640 X 1910 mm

						€
P	+2 / +10 °C	3	0,80	1355	335 - 375	8.620,00 €
NT	-15 / -25 °C	3	1,25	1355	330 - 370	9.560,00 €
NP	-15 / -25 °C +2 / +10 °C	3	1,08	1355	335 - 375	9.310,00 €
NFP	+10 / -5 °C	3	1,20	1330	325 - 365	10.340,00 €
NFN	+5 / -25 °C	3	1,55	1330	335 - 375	11.230,00 €
CB	+5 / -25 °C +10 / -5 °C	3	1,35	1330	330 - 370	11.070,00 €

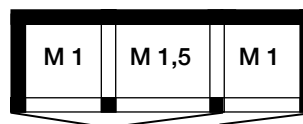

1 LATO ESPOSITIVO
1 GLAZED SIDE

1420

2200 X 640 X 1910 mm



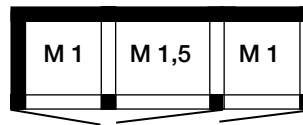
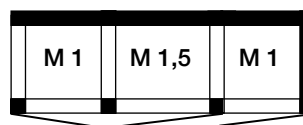
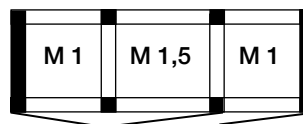





						€
P	+2 / +10 °C	3	0,90	1260	360 - 400	9.190,00 €
NT	-15 / -25 °C	3	1,65	1260	355 - 395	11.420,00 €
NP	-15 / -25 °C +2 / +10 °C	3	1,38	1260	360 - 400	10.120,00 €
NFP	+10 / -5 °C	3	1,26	1200	350 - 390	11.200,00 €
NFN	+5 / -25 °C	3	1,95	1200	360 - 400	13.450,00 €
CB	+5 / -25 °C +10 / -5 °C	3	1,60	1200	355 - 395	12.010,00 €



2 LATI ESPOSITIVI
2 GLAZED SIDES

2200 X 640 X 1910 mm

1430



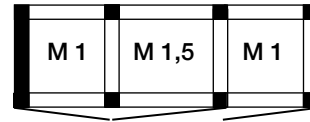
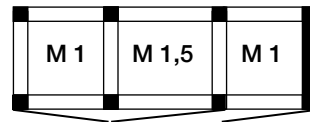
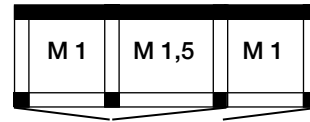





 						
P	+2 / +10 °C	3	1,25	1480	380 - 420	9.190,00 €
NT	-15 / -25 °C	3	2,10	1480	375 - 415	12.300,00 €
NP	-15 / -25 °C +2 / +10 °C	3	1,85	1480	380 - 420	10.690,00 €
NFP	+10 / -5 °C	3	1,55	1400	370 - 410	11.270,00 €
NFN	+5 / -25 °C	3	2,10	1400	380 - 420	14.490,00 €
CB	+5 / -25 °C +10 / -5 °C	3	1,80	1400	375 - 415	12.560,00 €



3 LATI ESPOSITIVI
3 GLAZED SIDES

2200 X 640 X 1910 mm

1440



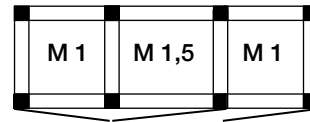





 						
P	+2 / +10 °C	3	1,25	1530	400 - 440	9.360,00 €
NT	-15 / -25 °C	3	2,25	1530	395 - 435	12.770,00 €
NP	-15 / -25 °C +2 / +10 °C	3	1,95	1530	400 - 440	11.070,00 €
NFP	+10 / -5 °C	3	1,55	1455	390 - 430	11.450,00 €
NFN	+5 / -25 °C	3	2,10	1455	400 - 440	15.030,00 €
CB	+5 / -25 °C +10 / -5 °C	3	1,80	1455	395 - 435	12.960,00 €



4 LATI ESPOSITIVI
4 SGLAZED SIDES

2200 X 640 X 1910 mm

1740

 						
P	+2 / +10 °C	2	1,25	1530	390 - 430	8.330,00 €
NP	-15 / -25 °C +2 / +10 °C	2	1,95	1530	390 - 430	9.130,00 €
NFP	+10 / -5 °C	2	1,55	1455	380 - 420	9.490,00 €
CB	+5 / -25 °C +10 / -5 °C	2	1,80	1455	395 - 425	10.440,00 €

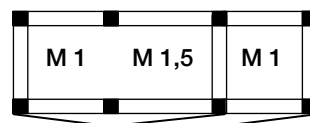

4 LATI ESPOSITIVI
4 GLAZED SIDES

1800

1780 X 640 X 1910 mm

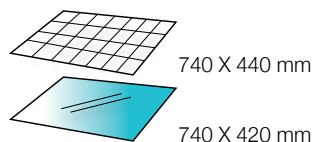

5+5 GRIGLIE
5+5 GRIDS
or
5+5 PIANI VETRO
5+5 GLASS SHELVES



SILVER



BRONZE



*modelli statici 1860 mm
static model 1860 mm

1810

1780 X 640 X 1910 mm

P	+2 / +10 °C	2	0,55	1160	253 - 295	6.140,00 €
NT	-15 / -25 °C	2	1,00	1160	263 - 305	6.890,00 €
NP	-15 / -25 °C +2 / +10 °C	2	0,80	1160	258 - 300	6.640,00 €
NFP	+10 / -5 °C	2	0,84	1115	255 - 297	6.710,00 €
NFN	+5 / -25 °C	2	1,10	1115	259 - 301	7.650,00 €
CB	+5 / -25 °C +10 / -5 °C	2	0,97	1115	257 - 299	7.200,00 €

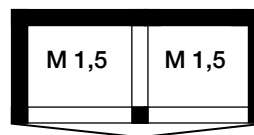

1 LATO ESPOSITIVO
1 GLAZED SIDE

1820

1780 X 640 X 1910 mm



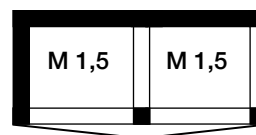
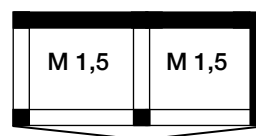
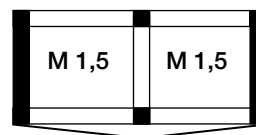





P	+2 / +10 °C	2	0,56	1230	275 - 317	6.350,00 €
NT	-15 / -25 °C	2	1,20	1230	285 - 327	8.020,00 €
NP	-15 / -25 °C +2 / +10 °C	2	0,85	1230	280 - 322	7.180,00 €
NFP	+10 / -5 °C	2	1,00	1185	273 - 315	7.300,00 €
NFN	+5 / -25 °C	2	1,36	1185	283 - 325	9.160,00 €
CB	+5 / -25 °C +10 / -5 °C	2	1,18	1185	278 - 319	8.190,00 €



2 LATI ESPOSITIVI
2 GLAZED SIDES

1780 X 640 X 1910 mm

1830



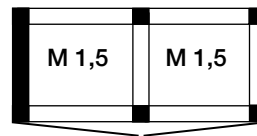
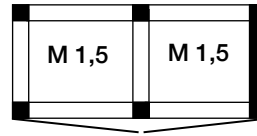
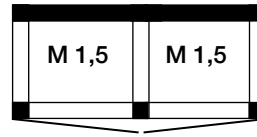





 						
P	+2 / +10 °C	2	0,90	1250	280 - 323	6.560,00 €
NT	-15 / -25 °C	2	1,40	1250	290 - 333	8.650,00 €
NP	-15 / -25 °C +2 / +10 °C	2	1,10	1250	285 - 328	7.590,00 €
NFP	+10 / -5 °C	2	1,00	1200	290 - 332	7.340,00 €
NFN	+5 / -25 °C	2	1,36	1200	300 - 342	9.850,00 €
CB	+5 / -25 °C +10 / -5 °C	2	1,18	1200	295 - 337	8.560,00 €



3 LATI ESPOSITIVI
3 GLAZED SIDES

1780 X 640 X 1910 mm

1840

 						
P	+2 / +10 °C	2	0,90	1260	305 - 348	7.340,00 €
NT	-15 / -25 °C	2	1,50	1260	315 - 358	9.850,00 €
NP	-15 / -25 °C +2 / +10 °C	2	1,20	1260	310 - 353	8.560,00 €
NFP	+10 / -5 °C	2	1,00	1210	310 - 352	7.470,00 €
NFN	+5 / -25 °C	2	1,40	1210	320 - 362	10.070,00 €
CB	+5 / -25 °C +10 / -5 °C	2	1,20	1210	315 - 357	8.760,00 €

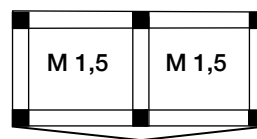

4 LATI ESPOSITIVI
4 GLAZED SIDES

2000

2660 X 640 X 1910 mm

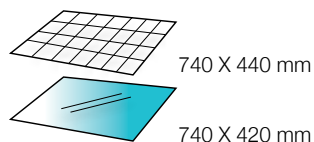

5+5+5 GRIGLIE
5+5+5 GRIDS
or
5+5+5 PIANI VETRO
5+5+5 GLASS SHELVES



SILVER



BRONZE

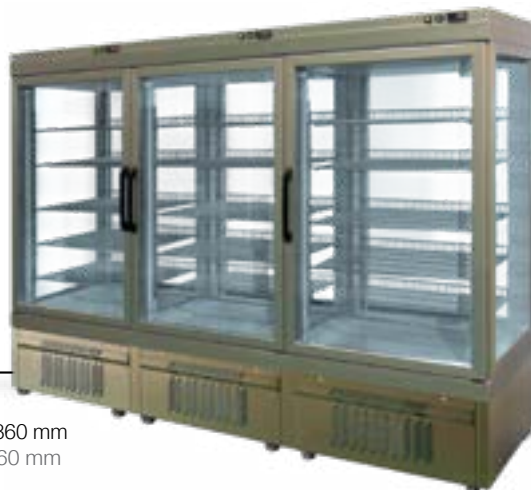

*modelli statici 1860 mm
static model 1860 mm

2010

2660 X 640 X 1910 mm

STATIC / NO FROST	TEMPERATURE	DOORS	KW	LITERS	KG	PRICE
P	+2 / +10 °C	3	0,90	1665	360 - 400	8.610,00 €
NT	-15 / -25 °C	3	1,35	1665	370 - 410	10.010,00 €
NP	-15 / -25 °C +2 / +10 °C	3	1,18	1665	365 - 405	9.300,00 €
NFP	+10 / -5 °C	3	1,30	1605	365 - 405	10.330,00 €
NFN	+5 / -25 °C	3	1,65	1605	375 - 415	11.810,00 €
CB	+5 / -25 °C +10 / -5 °C	3	1,40	1605	370 - 410	11.070,00 €

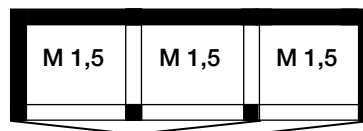

1 LATO ESPOSITIVO
1 GLAZED SIDE

2020

2660 X 640 X 1910 mm

STATIC / NO FROST	TEMPERATURE	DOORS	KW	LITERS	KG	PRICE
P	+2 / +10 °C	3	0,90	1770	385 - 425	9.340,00 €
NT	-15 / -25 °C	3	1,80	1770	395 - 435	11.960,00 €
NP	-15 / -25 °C +2 / +10 °C	3	1,48	1770	390 - 430	10.610,00 €
NFP	+10 / -5 °C	3	1,40	1710	390 - 430	11.210,00 €
NFN	+5 / -25 °C	3	2,15	1710	400 - 440	14.100,00 €
CB	+5 / -25 °C +10 / -5 °C	3	1,65	1710	395 - 435	12.620,00 €

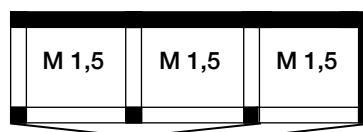
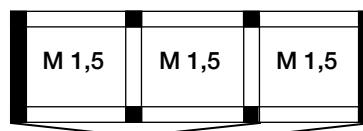



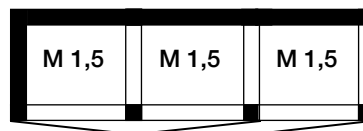





2 LATI ESPOSITIVI
2 GLAZED SIDES



2660 X 640 X 1910 mm

2030

 						
P	+2 / +10 °C	3	1,35	1860	405 - 445	9.660,00 €
NT	-15 / -25 °C	3	2,10	1860	415 - 455	12.890,00 €
NP	-15 / -25 °C +2 / +10 °C	3	1,85	1860	410 - 450	11.220,00 €
NFP	+10 / -5 °C	3	1,65	1770	410 - 450	11.270,00 €
NFN	+5 / -25 °C	3	2,20	1770	420 - 460	15.190,00 €
CB	+5 / -25 °C +10 / -5 °C	3	1,85	1770	415 - 455	13.190,00 €

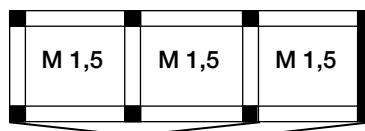
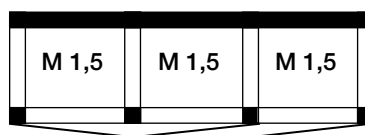



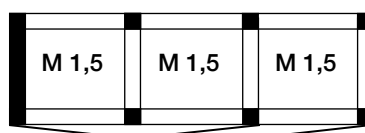





3 LATI ESPOSITIVI
3 GLAZED SIDES



2660 X 640 X 1910 mm

2040

 						
P	+2 / +10 °C	3	1,35	1890	425 - 465	9.830,00 €
NT	-15 / -25 °C	3	2,25	1890	435 - 475	13.440,00 €
NP	-15 / -25 °C +2 / +10 °C	3	1,95	1890	430 - 470	11.600,00 €
NFP	+10 / -5 °C	3	1,55	1785	430 - 470	11.440,00 €
NFN	+5 / -25 °C	3	2,20	1785	440 - 480	15.780,00 €
CB	+5 / -25 °C +10 / -5 °C	3	1,85	1785	435 - 475	13.600,00 €

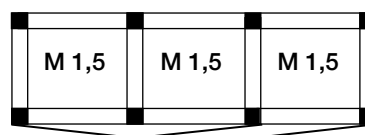

4 LATI ESPOSITIVI
4 GLAZED SIDES

1500

1970 X 640 X 1910 mm

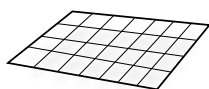

510 X 440 mm

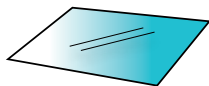

510 X 420 mm

5+5+5 GRIGLIE
5+5+5 GRIDS
OR
5+5+5 PIANI VETRO
5+5+5 GLASS SHELVES



SILVER



BRONZE



*modelli statici 1860 mm
static model 1860 mm

1510

1970 X 640 X 1910 mm

STATIC NO FROST	TEMPERATURE	DOOR	POWER (KW)	GLASS	WEIGHT (KG)	PRICE (€)
P	+2 / +10 °C	1	1,00	1350	380 - 420	5.110,00 €
NFP	+10 / -5 °C	1	1,00	1310	388 - 428	6.090,00 €
NFN	+5 / -25 °C	2	1,20	1310	398 - 438	7.560,00 €

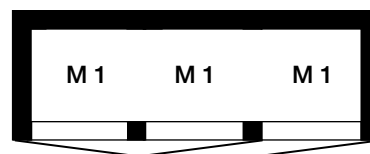

1 LATO ESPOSITIVO 1 GLAZED SIDE

1535

1970 X 640 X 1910 mm



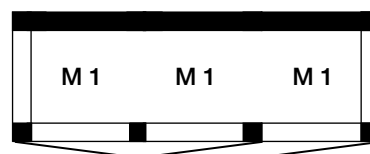





STATIC NO FROST	TEMPERATURE	DOOR	POWER (KW)	GLASS	WEIGHT (KG)	PRICE (€)
P	+2 / +10 °C	2	1,00	1350	382 - 422	5.370,00 €
NFP	+10 / -5 °C	2	1,00	1310	390 - 430	6.440,00 €
NFN	+5 / -25 °C	2	2,50	1310	400 - 440	10.070,00 €



3 LATI ESPOSITIVI 3 GLAZED SIDES

1970 X 640 X 1910 mm

1540



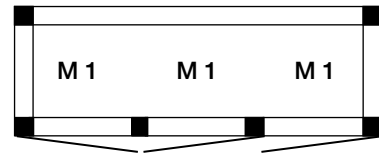





 						
P	+2 / +10 °C	2	1,20	1350	390 - 430	6.030,00 €
NFP	+10 / -5 °C	2	1,20	1310	395 - 435	6.740,00 €
NFN	+5 / -25 °C	2	2,50	1310	400 - 440	10.620,00 €



4 LATI ESPOSITIVI 4 GLAZED SIDES

1970 X 640 X 1910 mm

1541



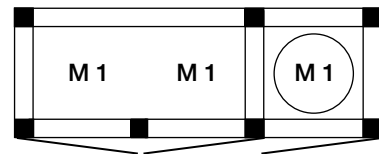





 						
P	+2 / +10 °C	2	1,20	1350	390 - 430	6.900,00 €
NP	-15 / -25 °C +2 / +10 °C	2	1,40	1350	390 - 430	8.160,00 €
NFP	+10 / -5 °C	2	1,20	1310	395 - 435	7.610,00 €
CB	+5 / -25 °C +10 / -5 °C	2	1,40	1310	400 - 440	8.360,00 €



4 LATI ESPOSITIVI 4 GLAZED SIDES

1970 X 640 X 1910 mm

1544

 						
P	+2 / +10 °C	2	1,20	1350	382 - 422	6.350,00 €
NT	-15 / -25 °C	2	1,40	1350	382 - 422	8.730,00 €
NP	-15 / -25 °C +2 / +10 °C	2	1,60	1350	390 - 430	6.960,00 €
NFP	+10 / -5 °C	2	1,20	1310	390 - 430	7.330,00 €
CB	+5 / -25 °C +10 / -5 °C	2	1,40	1310	400 - 440	8.050,00 €

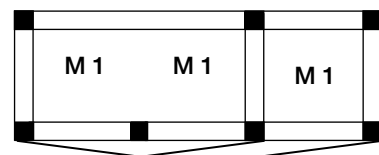

4 LATI ESPOSITIVI 4 GLAZED SIDES

1610

2430 X 640 X 1970 mm

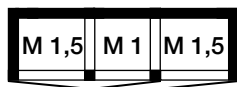

1 LATO ESPOSITIVO 1 GLAZED SIDE

*modelli statici 1860 mm static model 1860 mm

P			+2 / +10 °C	3	0,90	1510	340 - 380	9.130,00 €
NT			-15 / -25 °C	3	1,30	1510	350 - 390	10.120,00 €
NP			-15 / -25 °C +2 / +10 °C	3	1,08	1510	345 - 385	9.610,00 €
NFP			+10 / -5 °C	3	1,25	1510	340 - 380	10.420,00 €
NFN			+5 / -25 °C	3	1,60	1510	355 - 395	11.910,00 €
CB			+5 / -25 °C +10 / -5 °C	3	1,35	1510	345 - 385	11.170,00 €

1620

2430 X 640 X 1970 mm

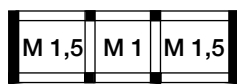

**2 LATI ESPOSITIVI
2 SGLAZED SIDES**

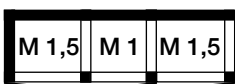
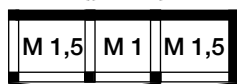

*modelli statici 1860 mm static model 1860 mm

P			+2 / +10 °C	3	0,88	1600	365 - 405	9.470,00 €
NT			-15 / -25 °C	3	1,70	1600	375 - 415	12.110,00 €
NP			-15 / -25 °C +2 / +10 °C	3	1,38	1600	370 - 410	10.230,00 €
NFP			+10 / -5 °C	3	1,356	1540	370 - 410	11.310,00 €
NFN			+5 / -25 °C	3	2,10	1540	380 - 420	14.260,00 €
CB			+5 / -25 °C +10 / -5 °C	3	1,60	1540	375 - 415	12.750,00 €

1630

2430 X 640 X 1970 mm

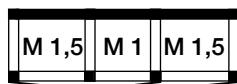

**3 LATI ESPOSITIVI
3 GLAZED SIDES**

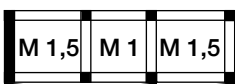

*modelli statici 1860 mm static model 1860 mm

P			+2 / +10 °C	3	1,30	1670	385 - 425	9.750,00 €
NT			-15 / -25 °C	3	2,10	1670	395 - 435	13.010,00 €
NP			-15 / -25 °C +2 / +10 °C	3	1,85	1670	390 - 430	10.820,00 €
NFP			+10 / -5 °C	3	1,60	1585	390 - 430	11.400,00 €
NFN			+5 / -25 °C	3	2,15	1585	400 - 440	15.340,00 €
CB			+5 / -25 °C +10 / -5 °C	3	1,80	1585	395 - 435	13.320,00 €

1640

2430 X 640 X 1970 mm

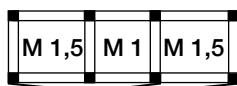

4 LATI ESPOSITIVI 4 GLAZED SIDES

*modelli statici 1860 mm static model 1860 mm

P			+2 / +10 °C	3	1,30	1710	405 - 445	9.920,00 €
NT			-15 / -25 °C	3	2,25	1710	415 - 455	13.570,00 €
NP			-15 / -25 °C +2 / +10 °C	3	1,95	1710	410 - 450	11.720,00 €
NFP			+10 / -5 °C	3	1,60	1620	410 - 450	11.550,00 €
NFN			+5 / -25 °C	3	2,15	1620	4230 - 460	15.940,00 €
CB			+5 / -25 °C +10 / -5 °C	3	1,80	1620	415 - 455	13.770,00 €

1644

2430 X 640 X 1970 mm

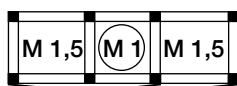

4 LATI ESPOSITIVI 4 GLAZED SIDES

*modelli statici 1860 mm static model 1860 mm

P			+2 / +10 °C	3	1,30	1710	413 - 453	10.600,00 €
NP			-15 / -25 °C +2 / +10 °C	3	1,95	1710	418 - 458	12.480,00 €
NFP			+10 / -5 °C	3	1,60	1620	418 - 458	12.600,00 €
NFN			+5 / -25 °C	3	2,15	1620	428 - 468	17.200,00 €
CB			+5 / -25 °C +10 / -5 °C	3	1,80	1620	423 - 463	14.890,00 €



CIELO *LINE*

C I E L O
L I N E

LATO OPERATORE OPERATOR SIDE

Apertura facilitata grazie all'ergonomia delle nostre maniglie in acciaio lucido che rendono pratico e funzionale l'utilizzo pur mantenendo la qualità estetica.

Easy opening thanks to the ergonomics of our polished steel handles that make its use practical and functional while maintaining aesthetic quality.

MANIGLIE LEXUS
HANDLES



LATO CLIENTE CUSTOMER SIDE

Ottima esposizione del prodotto grazie ai tre livelli differenziati e alla regolazione in altezza dei ripiani su cremagliera, i ripiani risultano così sospesi verso il lato espositivo permettendo l'intera visuale del prodotto per facilitare l'acquisto d'impulso.

Excellent exposure of the product thanks to the adjustable shelves on rack, the shelves are thus suspended towards clients side, that allows the entire view of the product to facilitate the sales.



RIPIANI VETRO
GLASS LEDGES

NR.2 1150 X 420 MM



REFRIGERAZIONE REFRIGERATION



AUTO



NO FROST

ACCESSORI ACCESSORIES



LED



AUTO



FINITURE ESTERNE EXTERNAL FINITURE



WHITE



BLACK



SILVER



BRONZE



RAL









WOOD

1 PORTA 1 DOOR

760 X 640 X 1210 mm

CIELO - 76

 NO FROST						
3LE NFP	+10 / -5 °C	1	0,40	214	125 - 140	5.050,00 €
3LE NFN	+5 / -25 °C	1	0,40	214	125 - 140	6.300,00 €
5LE NFP	+10 / -5 °C	1	0,60	214	125 - 140	5.240,00 €
5LE NFN	+5 / -25 °C	1	0,60	214	125 - 140	6.560,00 €

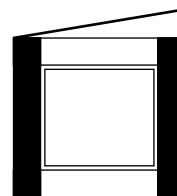

3 LATI ESPOSITIVI
3 GLAZED SIDES



SILVER

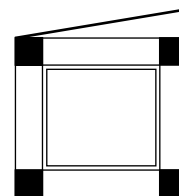

5 LATI ESPOSITIVI
5 GLAZED SIDES









BRONZE

1 PORTA 1 DOOR

900 X 640 X 1210 mm

CIELO - 90

 NO FROST						
3LE NFP	+10 / -5 °C	1	0,60	260	135 - 140	5.760,00 €
3LE NFN	+5 / -25 °C	1	0,70	260	135 - 140	7.270,00 €
5LE NFP	+10 / -5 °C	1	0,60	260	135 - 140	6.060,00 €
5LE NFN	+5 / -25 °C	1	0,70	260	135 - 140	7.580,00 €

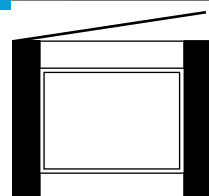

3 LATI ESPOSITIVI
3 GLAZED SIDES



SILVER

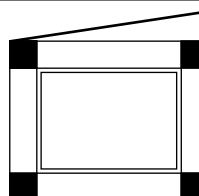

5 LATI ESPOSITIVI
5 GLAZED SIDES









BRONZE

2 PORTE 2 DOORS

1320 X 640 X 1210 mm

CIELO - 132

 NO FROST						
3LE NFP	+10 / -5 °C	1	0,80	396	150 - 165	6.560,00 €
3LE NFN	+5 / -25 °C	1	1,00	396	150 - 165	8.170,00 €
5LE NFP	+10 / -5 °C	1	0,80	396	150 - 165	6.820,00 €
5LE NFN	+5 / -25 °C	1	1,00	396	150 - 165	8.570,00 €

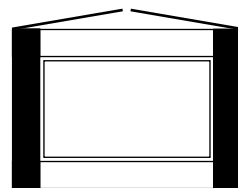

3 LATI ESPOSITIVI
3 GLAZED SIDES



SILVER

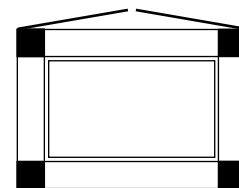

5 LATI ESPOSITIVI
5 GLAZED SIDES









BRONZE

2 PORTE 2 DOORS

1500 X 640 X 1210 mm

CIELO - 150

 NO FROST						
3LE NFP	+10 / -5 °C	1	1,00	455	165 - 180	7.960,00 €
3LE NFN	+5 / -25 °C	1	1,20	455	165 - 180	9.950,00 €
5LE NFP	+10 / -5 °C	1	1,00	455	165 - 180	8.230,00 €
5LE NFN	+5 / -25 °C	1	1,20	455	165 - 180	10.390,00 €

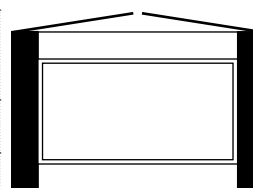

3 LATI ESPOSITIVI
3 GLAZED SIDES



SILVER

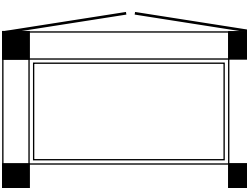

5 LATI ESPOSITIVI
5 GLAZED SIDES



BRONZE





sliding
collection

S L I D I N G
C O L L E C T I O N



SLIDING 9000



SILVER

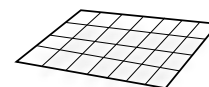

740 X 350 mm



BRONZE

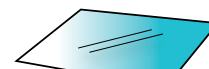

740 X 330 mm

3+3 GRIGLIE
3+3 GRIDS
or
3+3 PIANI VETRO
3+3 GLASS SHELVES



SILVER

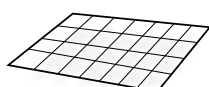

1150 X 350 mm



BRONZE

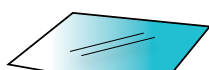

1150 X 330 mm









3 GRIGLIE
3 GRIDS
or
3 PIANI VETRO
3 GLASS SHELVES



SLIDING 7000

900 X 550 X 1910 mm

9100-S

 						
P	+2 / +10 °C	1	0,28	505	138 - 156	4.300,00 €
NFP	+2 / +10 °C	1	0,42	485	140 - 158	4.700,00 €



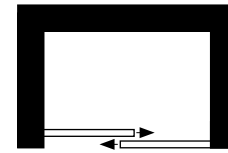





*modelli statici 1860 mm
static model 1860 mm



1 LATO ESPOSITIVO
1 GLAZED SIDE

900 X 550 X 1910 mm

9200-S

 						
P	+2 / +10 °C	1	0,28	540	150 - 168	4.750,00 €
NFP	+2 / +10 °C	1	0,50	520	152 - 170	5.240,00 €

*modelli statici 1860 mm
static model 1860 mm

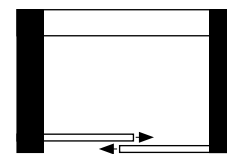



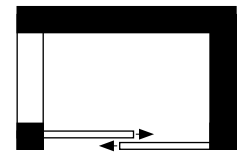
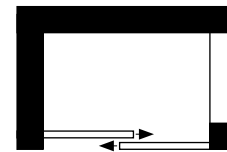





2 LATI ESPOSITIVI
2 GLAZED SIDES



900 X 550 X 1910 mm

9300-S

 						
P	+2 / +10 °C	1	0,45	570	153 - 170	4.810,00 €
NFP	+2 / +10 °C	1	0,50	520	157 - 175	5.310,00 €

*modelli statici 1860 mm
static model 1860 mm

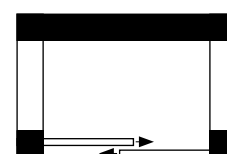



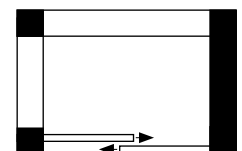
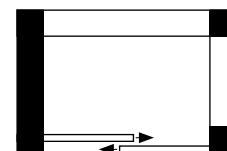





3 LATI ESPOSITIVI
3 GLAZED SIDES



900 X 550 X 1910 mm

9400-S

 						
P	+2 / +10 °C	1	0,45	580	166 - 184	4.890,00 €
NFP	+2 / +10 °C	1	0,50	525	166 - 184	5.370,00 €



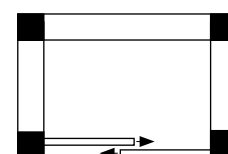





*modelli statici 1860 mm
static model 1860 mm



4 LATI ESPOSITIVI
4 GLAZED SIDES

7100-S

1320 X 550 X 1910 mm

	 						
P	+2 / +10 °C	1	0,52	775	180 - 217	5.430,00 €	
NFP	+2 / +10 °C	1	0,50	730	192 - 229	6.020,00 €	



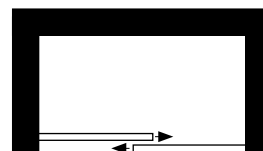





*modelli statici 1860 mm
static model 1860 mm



1 LATO ESPOSITIVO
1 GLAZED SIDE

7200-S

1320 X 550 X 1910 mm

	 						
P	+2 / +10 °C	1	0,56	825	203 - 240	5.950,00 €	
NFP	+2 / +10 °C	1	0,60	775	215 - 252	6.610,00 €	

*modelli statici 1860 mm
static model 1860 mm

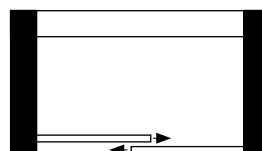



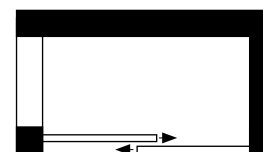





2 LATI ESPOSITIVI
2 GLAZED SIDES



7300-S

1320 X 550 X 1910 mm

	 						
P	+2 / +10 °C	1	0,80	855	235 - 272	6.000,00 €	
NFP	+2 / +10 °C	1	0,678	800	238 - 275	6.690,00 €	

*modelli statici 1860 mm
static model 1860 mm





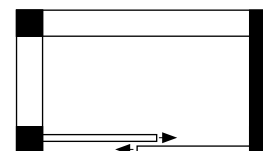





3 LATI ESPOSITIVI
3 GLAZED SIDES



7400-S

1320 X 550 X 1910 mm

	 						
P	+2 / +10 °C	1	0,80	855	235 - 272	6.030,00 €	
NFP	+2 / +10 °C	1	0,68	800	238 - 275	6.740,00 €	

*modelli statici 1860 mm
static model 1860 mm

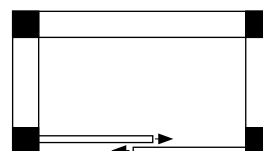

4 LATI ESPOSITIVI
4 GLAZED SIDES



wider
collection

W I D E R
COLLECTION



SILVER



BRONZE



MOTORE REMOTO
REMOTE
POWER UNIT

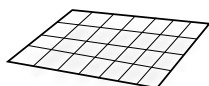

665 X 690 mm

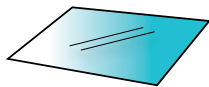

665 X 670 mm

NFN
7 GRIGLIE
7 GRIDS
or
7 PIANI VETRO
7 GLASS SHELVES

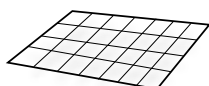

665 X 690 mm

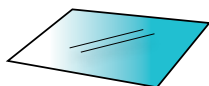

665 X 670 mm

NFP
5 GRIGLIE
5 GRIDS
or
5 PIANI VETRO
5 GLASS SHELVES

PORTATA MAX A RIPIANO 40 KG
MAX CAPACITY FOR SHELF 40 KG



WIDER1 (1LE)

825 X 890 X 2000 mm

NFP (1LE)	+10 / -5 °C	900	250 - 270	3.820,00 €
NFN (1LE)	+5 / -25 °C	900	250 - 270	4.590,00 €

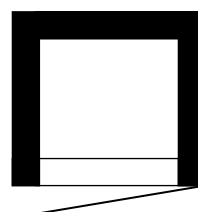

1 LATO ESPOSITIVO
1 GLAZED SIDE

WIDER1 (3LE)

825 X 890 X 2000 mm

NFP (3LE)	+10 / -5 °C	900	290 - 310	5.620,00 €
NFN (3LE)	+5 / -25 °C	900	290 - 310	7.380,00 €

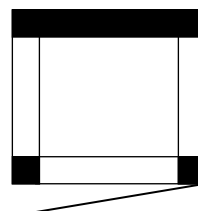

3 LATI ESPOSITIVI
3 GLAZED SIDES

WIDER1 (4LE)

825 X 890 X 2000 mm

NFP (4LE)	+10 / -5 °C	900	290 - 310	6.790,00 €
NFN (4LE)	+5 / -25 °C	900	290 - 310	8.650,00 €

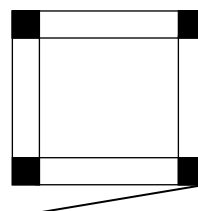

4 LATI ESPOSITIVI
4 GLAZED SIDES

 **SILVER**

 **BRONZE**

 **MOTORE REMOTO
REMOTE
POWER UNIT**

 665 X 690 mm

 665 X 670 mm

 665 X 690 mm

 665 X 670 mm

NFN
7+7 GRIGLIE
7+7 GRIDS
or
7+7 PIANI VETRO
7+7 GLASS SHELVES

NFP
5+5 GRIGLIE
5+5 GRIDS
or
5+5 PIANI VETRO
5+5 GLASS SHELVES





PORTATA MAX A RIPIANO 40 KG
MAX CAPACITY FOR SHELF 40 KG





1630 X 890 X 2000 mm

WIDER 2 (1LE)



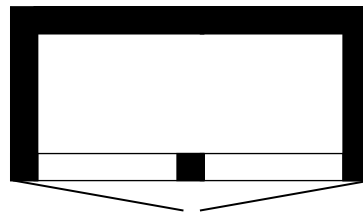

 NO FROST		 LT	 KG	
NFP (1LE)	+10 / -5 °C	1850	350 - 380	6.780,00 €
NFN (1LE)	+5 / -25 °C	1850	350 - 380	7.720,00 €



1 LATO ESPOSITIVO
1 GLAZED SIDE

1630 X 890 X 2000 mm

WIDER 2 (3LE)



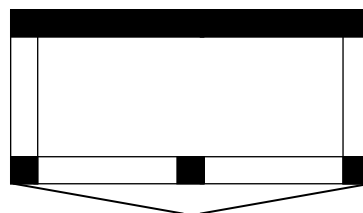

 NO FROST		 LT	 KG	
NFP (3LE)	+10 / -5 °C	1850	370 - 390	8.440,00 €
NFN (3LE)	+5 / -25 °C	1850	370 - 390	10.510,00 €



3 LATI ESPOSITIVI
3 GLAZED SIDES

1630 X 890 X 2000 mm

WIDER 2 (4LE)

 NO FROST		 LT	 KG	
NFP (4LE)	+10 / -5 °C	1850	370 - 390	9.880,00 €
NFN (4LE)	+5 / -25 °C	1850	370 - 390	13.070,00 €

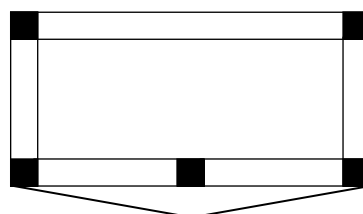

4 LATI ESPOSITIVI
4 GLAZED SIDES



665 X 690 mm
665 X 670 mm

NFN
7+7+7 GRIGLIE
7+7+7 GRIDS
or
7+7+7 PIANI VETRO
7+7+7 GLASS SHELVES

SILVER

BRONZE

665 X 690 mm
665 X 670 mm





NFP
5+5+5 GRIGLIE
5+5+5 GRIDS
or
5+5+5 PIANI VETRO
5+5+5 GLASS SHELVES

MOTORE REMOTO
REMOTE
POWER UNIT

PORTATA MAX A RIPIANO 40 KG
MAX CAPACITY FOR SHELF 40 KG

WIDER 3 (1LE)

2435 X 890 X 2000 mm



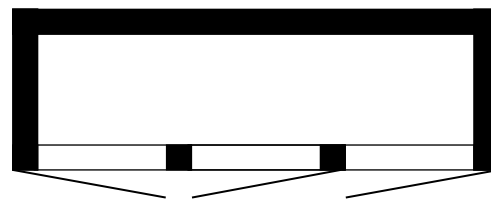

 NO FROST				
NFP (1LE)	+10 / -5 °C	2800	380 - 400	8.780,00 €
NFN (1LE)	+5 / -25 °C	2800	380 - 400	10.100,00 €



1 LATO ESPOSITIVO
1 GLAZED SIDE

WIDER 3 (3LE)

2435 X 890 X 2000 mm



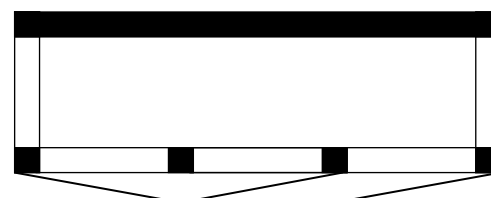

 NO FROST				
NFP (3LE)	+10 / -5 °C	2800	390 - 410	10.840,00 €
NFN (3LE)	+5 / -25 °C	2800	390 - 410	12.980,00 €



3 LATI ESPOSITIVI
3 GLAZED SIDES

WIDER 3 (4LE)

2435 X 890 X 2000 mm

 NO FROST				
NFP (4LE)	+10 / -5 °C	2800	390 - 410	12.330,00 €
NFN (4LE)	+5 / -25 °C	2800	390 - 410	16.640,00 €



4 LATI ESPOSITIVI
4 GLAZED SIDES

TABELLA GRUPPI CONSIGLIATI PER LINEA WIDER - POSITIVA

RECOMMENDED GROUP FOR WIDER LINE - POSITIVE

WIDER 1 NFP

	1 LATO ESPOSITIVO 1 SIDE GLASS	3 LATI ESPOSITIVI 3 GLAZED SIDES	4 LATI ESPOSITIVI 4 GLAZED SIDES	PREZZO PRICE
UC FRASCOLD A0,5-4Y R404A V.400/3/50	inferiore 10 mt under 10 mt			5.040,00 €
UC FRASCOLD A0,7-5Y R404A V.400/3/50	superiore 10 mt over 10 mt	inferiore 10 mt under 10 mt	inferiore 10 mt under 10 mt	5.080,00 €
UC FRASCOLD A16Y R404A V.400/3/50		superiore 10 mt over 10 mt	superiore 10 mt over 10 mt	5.130,00 €

*inclusi: quadro elettrico e cablaggio electrical box and cable included

WIDER 2 NFP

	1 LATO ESPOSITIVO 1 SIDE GLASS	3 LATI ESPOSITIVI 3 GLAZED SIDES	4 LATI ESPOSITIVI 4 GLAZED SIDES	PREZZO PRICE
UC FRASCOLD A0,7-5Y R404A V.400/3/50	inferiore 10 mt under 10 mt			5.080,00 €
UC FRASCOLD A16Y R404A V.400/3/50	superiore 10 mt over 10 mt	inferiore 10 mt under 10 mt	inferiore 10 mt under 10 mt	5.130,00 €
UC FRASCOLD A1,5-7Y R404 V.400/3/50		superiore 10 mt over 10 mt	superiore 10 mt over 10 mt	5.310,00 €

*inclusi: quadro elettrico e cablaggio electrical box and cable included

WIDER 3 NFP

	1 LATO ESPOSITIVO 1 SIDE GLASS	3 LATI ESPOSITIVI 3 GLAZED SIDES	4 LATI ESPOSITIVI 4 GLAZED SIDES	PREZZO PRICE
UC FRASCOLD A1,5-7Y R404 V.400/3/50	inferiore 10 mt under 10 mt			5.310,00 €
UC FRASCOLD A1,5-8Y R404 V.400/3/50	superiore 10 mt over 10 mt	inferiore 10 mt under 10 mt	inferiore 10 mt under 10 mt	5.380,00 €
UC FRASCOLD B1,5-9Y R404 V.400/3/50		superiore 10 mt over 10 mt	superiore 10 mt over 10 mt	5.720,00 €

*inclusi: quadro elettrico e cablaggio electrical box and cable included

dati tecnici comuni

filtro - indicatore - solenoide liquido - pressostato - parzializzazione ventole - separatore di liquido - predisposizione per sbrinamento a gas caldo con valvola solenoide montata - rubinetto

technical data

filter - indicator - liquid solenoid - pressure switch - fans controller - liquid separator - arrangement for hot gas defrost with solenoid valve mounted

TABELLA GRUPPI CONSIGLIATI PER LINEA WIDER - NEGATIVA

RECOMMENDED GROUP FOR WIDER LINE - NEGATIVE

WIDER 1 NFN

	1 LATO ESPOSITIVO 1 SIDE GLASS	3 LATI ESPOSITIVI 3 GLAZED SIDES	4 LATI ESPOSITIVI 4 GLAZED SIDES	PREZZO PRICE
UC FRASCOLD A0,5-5Y R404A V.400/3/50	inferiore 10 mt under 10 mt			5.210,00 €
UC FRASCOLD A0,7-6Y R404A V.400/3/50	superiore 10 mt over 10 mt	inferiore 10 mt under 10 mt	inferiore 10 mt under 10 mt	5.250,00 €
UC FRASCOLD A1-7Y R404A V.400/3/50		superiore 10 mt over 10 mt	superiore 10 mt over 10 mt	5.300,00 €

*inclusi: quadro elettrico e cablaggio electrical box and cable included

WIDER 2 NFN

	1 LATO ESPOSITIVO 1 SIDE GLASS	3 LATI ESPOSITIVI 3 GLAZED SIDES	4 LATI ESPOSITIVI 4 GLAZED SIDES	PREZZO PRICE
UC FRASCOLD B1,5-10Y R404 V.400/3/50	inferiore 10 mt under 10 mt			5.910,00 €
UC FRASCOLD D2-13Y R404A V.400/3/50	superiore 10 mt over 10 mt	inferiore 10 mt under 10 mt	inferiore 10 mt under 10 mt	6.410,00 €
UC FRASCOLD D2-15Y R404A V.400/3/50		superiore 10 mt over 10 mt	superiore 10 mt over 10 mt	6.520,00 €

*inclusi: quadro elettrico e cablaggio electrical box and cable included

WIDER 3 NFN

	1 LATO ESPOSITIVO 1 SIDE GLASS	3 LATI ESPOSITIVI 3 GLAZED SIDES	4 LATI ESPOSITIVI 4 GLAZED SIDES	PREZZO PRICE
UC FRASCOLD D2-13Y R404A V.400/3/50	inferiore 10 mt under 10 mt			6.410,00 €
UC FRASCOLD D2-15Y R404A V.400/3/50	superiore 10 mt over 10 mt	inferiore 10 mt under 10 mt	inferiore 10 mt under 10 mt	6.520,00 €
UC FRASCOLD D3-16Y R404A V.400/3/50		superiore 10 mt over 10 mt	superiore 10 mt over 10 mt	7.790,00 €

*inclusi: quadro elettrico e cablaggio electrical box and cable included

dati tecnici comuni

filtro - indicatore - solenoide liquido - pressostato - parzializzazione ventole - separatore di liquido - predisposizione per sbrinamento a gas caldo con valvola solenoide montata - rubinetto

technical data

filter - indicator - liquid solenoid - pressure switch - fans controller - liquid separator - arrangement for hot gas defrost with solenoid valve mounted









KOALA *line*

K O A L A
L I N E

KOA-1

670 X 640 X 2250 mm

 						€
NT	-15/-25 °C	1	0,90	500	315 - 345	5.390,00 €
NFN	+5 / -25 °C	1	1,40	500	330 - 360	7.010,00 €



SILVER



BRONZE

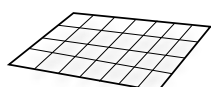

510 X 440 mm

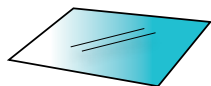

510 X 420 mm

7 GRIGLIE
7 GRIDS
or
7 PIANI VETRO
7 GLASS SHELVES

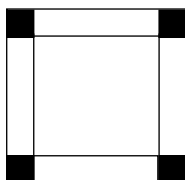







4 LATI ESPOSITIVI
4 GLAZED SIDES



KOA-2

900 X 640 X 2250 mm

 						€
NT	-15/-25 °C	1	0,90	600	340 - 355	7.040,00 €
NFN	+5 / -25 °C	1	1,40	600	360 - 375	7.510,00 €



SILVER



BRONZE

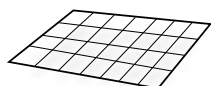

740 X 440 mm

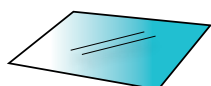

740 X 420 mm

7 GRIGLIE
7 GRIDS
or
7 PIANI VETRO
7 GLASS SHELVES

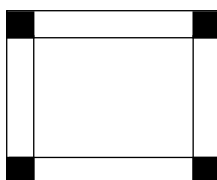

4 LATI ESPOSITIVI
4 GLAZED SIDES





C A R ■ L I N E

KIT CARNE

Kit per la conservazione e la vendita diretta.
Kit for storage and direct sales.

Kit Car è usato nell'esposizione e nella conservazione della carne.
Queste vetrine sono una soluzione ideale per la vendita di carne per tutte le macellerie.
The Car Kit is used for meat storage and display.
These showcases are an ideal solution for meat sales for butchers and restaurants.









KIT CAR

KIT MATURAZIONE

KIT MATURATION HR 30% - 80%.

Kit per la conservazione e la maturazione oltre 12 mesi.
Kit for storage and aging over to 12 months.

Kit di maturazione consente di ottenere carni con caratteristiche organolettiche superiori.
Grazie ad un software specifico di gestione della temperatura è possibile la conservazione del prodotto per lunghi periodi.
The aging Kit is used to obtain meat that needs a long dry aging with a plus characteristics.
The temperature and controlled humidity allow the constant maturation for the long period.

Refrigerazione <i>Refrigeration</i>		No-Frost
Serie <i>Series</i>		No frost positiva <i>No frost positive</i>
Range Temperature		+20°/0° C
Range Umidità		Regolabile dal 30% all'80% <i>Adjustable from 30% to 80%</i>
Sbrinamento <i>Defrosting</i>		Automatico Elettrico <i>Automatic electrical</i>
Motore <i>Engine</i>		Incluso o Remoto <i>Included o remote</i>
Gas		R452
Finitura interna <i>Internal Finishing</i>		Inox Aisi 304
Assetto interno <i>Internal structure</i>		Griglie in acciaio Inox + ganciera per carne <i>Inox Grates Ledges + tube inox for meat</i>

INFORMAZIONI INFORMATION

Per soddisfare tutte le vostre esigenze la tecnologia carne si puo' applicare a qualsiasi modello Tekna.

To satisfy all your needs the "meat technology" can be applied to all Tekna showcases.

Possibilità di avere da 1 a 4 lati espositivi.
Possibility to have from 1 to 4 glass sides.

Finitura esterna RAL optional.
Optional: External RAL finish.

Dimensioni personalizzabili.
Customizable sizes.

La vetrina standard è solo per l'esposizione.
Il Kit maturazione è optional.
The standard showcase is for display only.
The maturation kit is optional.



**TEMPO
MATURAZIONE
CARNE
DA 1 A 6 MESI**

**DRY AGING TIME
FROM 1 TO 6 MONTHS**



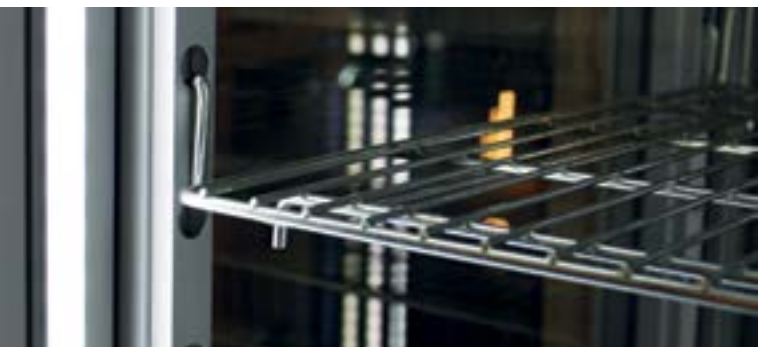

TERMOSTATO

1 CONTROLLER

Termostato Digitale Touch Screen per controllo temperatura umidità ventilazione.

Digital Touch Screen Thermostat to control ventilation humidity temperature.

LAMPADA UVC GERMICIDA

2 UVC GERMICIDAL LAMP

La lampada UVC germicida posta all'interno dell'evaporatore serve per contrastare la carica batterica che si genera all'interno della vetrina.

UVC germicidal lamp is placed inside the evaporator and it's useful to avoid bacterial attack that is generated inside the showcase.

GANCIERE IN ACCIAIO INOX

3 TUBE INOX

Ganciera inox, sulla quale è possibile appendere come optional i ganci per carne.

Tube inox, on which it is possible to hang hooks like optional.

VALVOLA ESPANSIONE ED EVAPORATORE

4 EXPANSION AND EVAPORATOR VALVE

Valvola per il controllo dell'evaporazione. Evaporatore trattato in cataforesi per conferire una notevole resistenza alla corrosione.

Expansion valve for evaporation control. Cathaphoresis evaporator to guarantee a better resistance to corrosion.

GRIGLIE INOX

5 INOX GRATES LEDGES

Resistenti griglie in acciaio inox e supporti coordinati per garantire un'ottima esposizione dei prodotti.

Resistant stainless steel grids and coordinated supports to ensure an excellent exposure of products.

ILLUMINAZIONE A LED ROSA

6 PINK LED LIGHTING







Valorizza il colore naturale della carne, non contiene alcuna radiazione ultravioletta e non influenza la temperatura interna alla vetrina.

It enhance the natural colour of meat, it doesn't contain any ultraviolet radiation and it does not influence the temperature inside the showcase.

760 X 760 X 1910 mm

CAR 1

* CON KIT MATURAZIONE ALTEZZA 1990 mm WITH MATURATION KIT HEIGHT 1990 mm



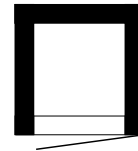



						
NFP	-5 / +10 °C	1	0,50	540	190 - 205	4.450,00 €



CAR 1 - 1 LE

1 LATO ESPOSITIVO
1 SGLAZED SIDE

*optional: kit maturazione 3.030,00 € *altezza vetrina con kit maturazione 1990 mm
*optional: maturation kit 3.030,00 € *showcase height with maturation kit 1990 mm

						
NFP	-5 / +10 °C	1	0,50	540	190 - 205	4.780,00 €

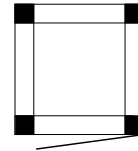

CAR 1 - 4 LE

4 LATI ESPOSITIVI
4 SGLAZED SIDES

*optional: kit maturazione 3.030,00 € *altezza vetrina con kit maturazione 1990 mm
*optional: maturation kit 3.030,00 € *showcase height with maturation kit 1990 mm



600 X 560 mm
2 GRIGLIE
2 GRIDS



600 mm
2 TUBI INOX PER GANCI
2 INOX HANGING TUBES
FOR HOOKS



SILVER



BRONZE









100 Kg

circa 30 Kg per ripiano
about 30 kg for shelf

1500 X 760 X 1910 mm

CAR 2

* CON KIT MATURAZIONE ALTEZZA 1990 mm WITH MATURATION KIT HEIGHT 1990 mm



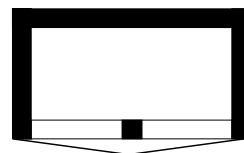

						
NFP	-5 / +10 °C	1	1,00	1000	280 - 300	6.240,00 €



CAR 2 - 1 LE

1 LATO ESPOSITIVO
1 SGLAZED SIDE

*optional: kit maturazione 3.030,00 € *altezza vetrina con kit maturazione 1990 mm
*optional: maturation kit 3.030,00 € *showcase height with maturation kit 1990 mm

						
NFP	-5 / +10 °C	1	1,00	1000	280 - 300	6.570,00 €

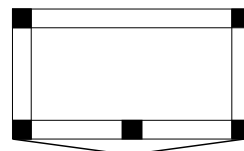

CAR 2 - 4 LE

4 LATI ESPOSITIVI
4 SGLAZED SIDES

*optional: kit maturazione 3.030,00 € *altezza vetrina con kit maturazione 1990 mm
*optional: maturation kit 3.030,00 € *showcase height with maturation kit 1990 mm



600 X 560 mm
2+2 GRIGLIE
2+2 GRIDS



1340 mm
2 TUBI INOX PER GANCI
2 INOX HANGING TUBES
FOR HOOKS



SILVER



BRONZE









200 Kg

circa 50 Kg per ripiano
about 50 kg for shelf

CAR 3

900 X 760 X 1910 mm

* CON KIT MATURAZIONE ALTEZZA 1990 mm WITH MATURATION KIT HEIGHT 1990 mm

						
NFP	-5 / +10 °C	1	0,60	700	210 - 255	5.410,00 €

*optional: kit maturazione 3.030,00 €
 *optional: maturation kit 3.030,00 €
 *altezza vetrina con kit maturazione 1990 mm
 *showcase height with maturation kit 1990 mm

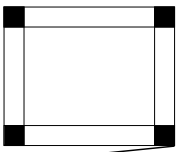

4 LATI ESPOSITIVI
4 GLAZED SIDES



740 X 560 mm
2 GRIGLIE
2 GRIDS



740 mm
2 TUBI INOX PER GANCI
2 INOX HANDING TUBES
FOR HOOKS



150 Kg



SILVER









BRONZE

CAR 4

1780 X 760 X 1910 mm

* CON KIT MATURAZIONE ALTEZZA 1990 mm WITH MATURATION KIT HEIGHT 1990 mm

						
NFP	-5 / +10 °C	1	1,20	1420	300 - 325	7.410,00 €

*optional: kit maturazione 3.030,00 €
 *optional: maturation kit 3.030,00 €
 *altezza vetrina con kit maturazione 1990 mm
 *showcase height with maturation kit 1990 mm

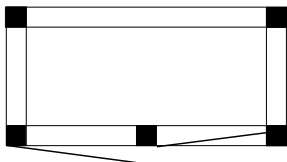

4 LATI ESPOSITIVI
4 GLAZED SIDES



740 X 560 mm
2+2 GRIGLIE
2+2 GRIDS



1620 mm
2 TUBI INOX PER GANCI
2 INOX HANDING TUBES
FOR HOOKS



300 Kg



SILVER



BRONZE

CAR 5

2500 X 760 X 1910 mm

* CON KIT MATURAZIONE ALTEZZA 1990 mm WITH MATURATION KIT HEIGHT 1990 mm

				
NFP	-5 / +10 °C	2800	390 - 410	8.890,00 €

*optional: kit maturazione 3.030,00 €
 *optional: maturation kit 3.030,00 €
 *altezza vetrina con kit maturazione 1990 mm
 *showcase height with maturation kit 1990 mm



4 LATI ESPOSITIVI
4 GLAZED SIDES



665 X 560 mm
2+2+2 GRIGLIE
2+2+2 GRIDS



2200 mm
2 TUBI INOX PER GANCI
2 INOX HANDING TUBES
FOR HOOKS



800 Kg



SILVER



BRONZE



LINE SALUMI

S A L U M I
L I N E



Tekna propone una linea di vetrine refrigerate verticali dedicata all'esposizione e conservazione dei salumi, grazie alla gestione dei cicli di asciugatura e stagionatura, offrendo la possibilità di stagionare i salumi in maniera naturale.

Grazie ad un controllo sistematico della temperatura, ventilazione ed umidità è possibile stagionare i salumi all'interno di un ambiente asettico, evitando sbalzi di temperatura improvvisi e correnti d'aria esterne.

Tekna is here proposing a vertical refrigerated display cases dedicated to the exposure and storage of "salumi". It offers also the possibility of its maturation in a natural way and aseptic environment thanks to a systematic control of the temperature, ventilation and humidity to avoid sudden changes in temperature.

**REALIZZABILI SU MISURA:
DIMENSIONI MINIME
RICHIESTE
DA 670MM DI LARGHEZZA X
640MM DI PROFONDITA'**

**TAYLOR MADE:
MIN. DIMENSION REQUESTED
FROM 670MM WIDTH
640 MM DEPTH**

Lampada Led Rosa per Carne

Pink Led Lighting for Meat

Controllo umidità

Humidity Viewer

Controllo ventilazione

Fan Speed Controller

Cicli preimpostati per la stagionatura

Drying maturation

Ricambio dell'aria

Air Replacement

Carico e scarico segnalato da spie luminose quando il livello dell'acqua è troppo basso o è adeguato

Load and Unload noticed by warning lights when the water level is too low or appropriate

Refrigerazione
Refrigeration



No-Frost

Serie
Series



No frost positiva
No frost positive

Range Temperature



+10°/+30° C

Sbrinamento
Defrosting



Automatico a gas caldo
Automatic with hot gas

Motore
Engine



Incluso, nella parte alta
Included, on top

Gas



R452

Lati vetro
Sides Glasses



N.1 solo porte
Only doors

Assetto interno
Internal structure



Griglie in acciaio Inox + ganciera per carne
Inox Grates Ledges + tube inox for meat

Finitura esterna
External Finishing



Inox Aisi 304

CONTROLLORI TEMPERATURA E UMIDITA' PER CICLI DI STAGIONATURA

TEMPERATURE AND HUMIDITY CONTROLLERS FOR MATURING

Grazie allo strumento che consente il controllo di temperatura e umidità per cicli di stagionatura dei salumi, è possibile impostare i 6 cicli di stagionatura riportati di seguito:

Thanks to the tool that allows temperature and humidity control for maturing, it is possible to set the following 6 maturing cycles:

	STUFATURA STEWING	ASC 1 DRYING 1	ASC 2 DRYING 2	ASC 3 DRYING 3	ASC 4 DRYING 4	ASC 5 DRYING 5	ASC 6 DRYING 6	STAGIONATURA AGING
DURATA DURATION	10 ore 10 hours	15 ore 15 hours	24 ore 24 hours	24 ore 24 hours	24 ore 24 hours	24 ore 24 hours	24 ore 24 hours	1 giorno 1 day
SET 1 TEMPERATURA SET 1 TEMPERATURE	20 °C	19 °C	19 °C	18 °C	17 °C	16 °C	15 °C	14 °C
SET 2 UMIDITA' SET 2 HUMIDITY	0 %	75 %	68 %	65 %	68 %	72 %	76 %	82 %
VENTILAZIONE RIDOTTA REDUCED VENTILATION	no	no	no	no	no	no	no	no
RINVENIMENTO REVIVE	no	si yes	si yes	si yes	si yes	si yes	si yes	no
SBRINAMENTO DE-FROST	manuale manual	manuale manual	manuale manual	manuale manual	manuale manual	manuale manual	manuale manual	manuale manual
RICAMBIO ARIA AIR SPARE	manuale manual	manuale manual	manuale manual	manuale manual	manuale manual	manuale manual	manuale manual	manuale manual



Questa elettronica dedicata consente di impostare e configurare personalmente i cicli, modificandoli a proprio piacimento; Qui sotto viene riportato il ciclo base fornito in dotazione:



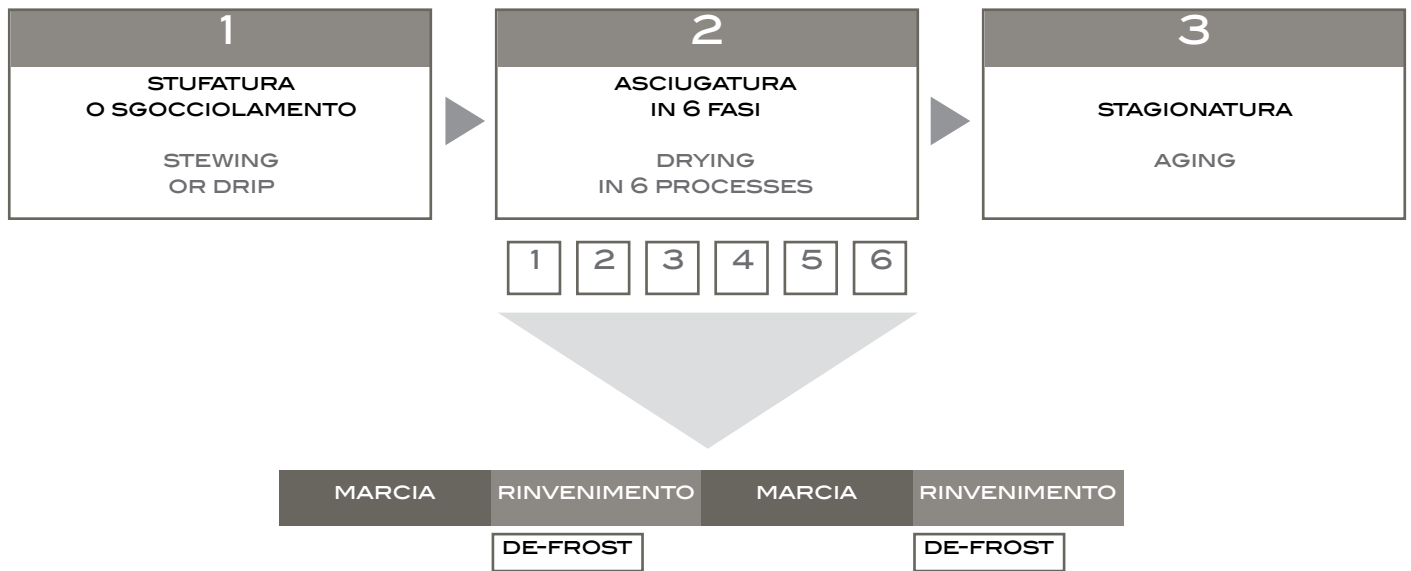



This dedicated electronics allows you to set and configure the cycles yourself, modifying them as you wish; The basic cycle supplied is shown below:



SALUMI

SAL 5010

670 X 890 X 1990 mm

						
NFP	-5 / +10 °C	1	0,50	540	190 - 205	8.950,00 €

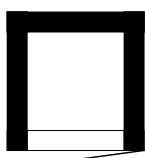
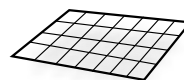

1 LATO ESPOSITIVO
1 GLAZED SIDE



510 X 690 mm

2 GRIGLIE
2 GRIDS



1 TUBO INOX PER GANCI
1 INOX HANDING TUBE
FOR HOOKS









SILVER



BRONZE

SAL 5020

825 X 890 X 1990 mm

						
NFP	-5 / +10 °C	1	0,60	7000	210 - 255	9.570,00 €

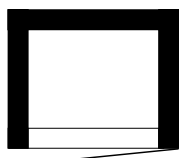

1 LATO ESPOSITIVO
1 GLAZED SIDE



000 X 690 mm

2 GRIGLIE
2 GRIDS



1 TUBO INOX PER GANCI
1 INOX HANDING TUBE
FOR HOOKS









SILVER



BRONZE

SAL 9501

1320 X 890 X 1990 mm

						
NFP	-5 / +10 °C	1	1,00	1000	280 - 300	10.250,00 €

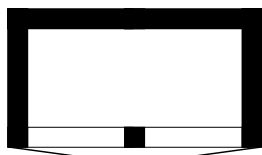

1 LATO ESPOSITIVO
1 GLAZED SIDE

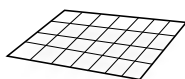

000 X 690 mm

2 GRIGLIE
2 GRIDS



2 TUBI INOX PER GANCI
2 INOX HANDING TUBES
FOR HOOKS



SILVER



BRONZE



W A L L . L I N E

WALL

I pensili refrigerati di Tekna sono nati per soddisfare le esigenze del cliente, sfruttando la parete nella sua altezza per permettere l'esposizione e la conservazione dei prodotti anche in spazi ridotti.

Questo permette di avere al di sotto del pensile un piano di lavoro utilizzabile senza ingombri.

Ideale per bar, pasticcerie, gelaterie, laboratori, gastronomie, macellerie.

Tekna refrigerated wall units were born to satisfy customer needs using the wall in all its height.

Our wall series allows customers to expose its products, preserve its qualities and saving space.

They are perfect for coffee shops, bakeries, laboratory, gastronomy and butcher shops.



Refrigerazione
Refrigeration



No-Frost

Serie
Series



No frost positiva
No frost positive

Range Temperature



+2°/+10° C

Sbrinamento
Defrosting



Automatico Elettrico
Automatic electrical

Motore
Engine



Remoto, incluso fino a 15mt
Remote, included until 15mt

Gas



R452

Lati vetro
Glazed Sides



1 (a richiesta fino a 4)
1 (on request up to 4)

Assetto interno
Internal structure



Ripiani in Acciaio Inox
Inox Ledges

Finitura esterna
External Finishing



Inox Aisi 304



SU RICHIESTA ■ ON REQUEST:



■ **KIT MATURAZIONE**
 ALTEZZA MINIMA CONSIGLIATA 1200 MM,
 PROFONDITA' 640 MM
MATURATION KIT
 MINIMUM RECOMMENDED
 HEIGHT 1200 MM, DEPTH 640 MM



■ **REALIZZABILI VETRINE CON 3 O 4
 LATI VETRO**
 SHOWCASES PRODUCED WITH 3
 OR 4 GLASS SIDES

■ **STAFFE DI FISSAGGIO A MURO**
 WALL-MOUNTING BRACKETS

PREZZO NETTO / NET PRICE € 100,00 cad.

1000 X 550 X 880 mm* **WALL 100**

* CON KIT MATURAZIONE 640 X 1200 mm WITH MATURATION KIT 640 X 1200 mm

 NO FROST		PORTE SCORREVOLI SLIDING DOORS	RIPIANI INOX INOX LEDGES	ILLUMINAZIONE LED LED LIGHTING	€
NFP	+2 / +10 °C	2	2	2+2 6000°K	4.080,00 €

*optional:
 kit maturazione 3.030,00 €
 *optional:
 maturation kit 3.030,00 €
 *altezza vetrina
 con kit maturazione 1200 mm
 *showcase height
 with maturation kit 1200 mm

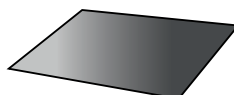

2 PIANI INOX
 2 INOX SHELVES





**BRUSHED
 STEEL**



BLACK

1500 X 550 X 880 mm **WALL 150**

* CON KIT MATURAZIONE 640 X 1200 mm WITH MATURATION KIT 640 X 1200 mm

 NO FROST		PORTE SCORREVOLI SLIDING DOORS	RIPIANI INOX INOX LEDGES	ILLUMINAZIONE LED LED LIGHTING	€
NFP	+2 / +10 °C	2	2	2+2 6000°K	4.930,00 €

*optional:
 kit maturazione 3.030,00 €
 *optional:
 maturation kit 3.030,00 €
 *altezza vetrina
 con kit maturazione 1200 mm
 *showcase height
 with maturation kit 1200 mm

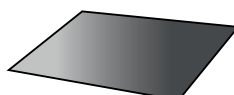

2 PIANI INOX
 2 INOX SHELVES



**BRUSHED
 STEEL**





BLACK

WALL 200

2000 X 550 X 880 mm

* CON KIT MATURAZIONE 640 X 1200 mm WITH MATURATION KIT 640 X 1200 mm

 NO FROST		PORTE SCORREVOLI SLIDING DOORS	RIPIANI INOX INOX LEDGES	ILLUMINAZIONE LED LED LIGHTING	€
NFP	+2 / +10 °C	2	2	2+2 6000°K	6.420,00 €

*optional:
kit maturazione 3.030,00 €
*optional:
maturation kit 3.030,00 €
*altezza vetrina
con kit maturazione 1200 mm
*showcase height
with maturation kit 1200 mm

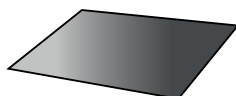
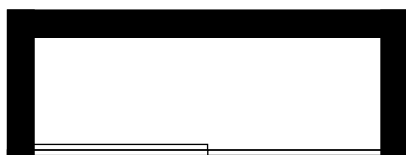

2 PIANI INOX
2 INOX SHELVES



BRUSHED
STEEL





BLACK

WALL 250

2500 X 550 X 880 mm

* CON KIT MATURAZIONE 640 X 1200 mm WITH MATURATION KIT 640 X 1200 mm

 NO FROST		PORTE SCORREVOLI SLIDING DOORS	RIPIANI INOX INOX LEDGES	ILLUMINAZIONE LED LED LIGHTING	€
NFP	+2 / +10 °C	3	2+2+2	2+2+2 6000°K	7.830,00 €

*optional:
kit maturazione 3.030,00 €
*optional:
maturation kit 3.030,00 €
*altezza vetrina
con kit maturazione 1200 mm
*showcase height
with maturation kit 1200 mm

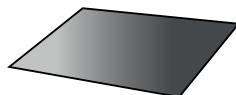

2 PIANI INOX
2 INOX SHELVES



BRUSHED
STEEL





BLACK

WALL 300

3000 X 550 X 880 mm

* CON KIT MATURAZIONE 640 X 1200 mm WITH MATURATION KIT 640 X 1200 mm

 NO FROST		PORTE SCORREVOLI SLIDING DOORS	RIPIANI INOX INOX LEDGES	ILLUMINAZIONE LED LED LIGHTING	€
NFP	+2 / +10 °C	3	2+2+2	2+2+2 6000°K	9.740,00 €

*optional:
kit maturazione 3.030,00 €
*optional:
maturation kit 3.030,00 €
*altezza vetrina
con kit maturazione 1200 mm
*showcase height
with maturation kit 1200 mm

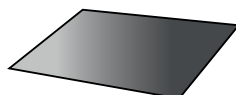

2 PIANI INOX
2 INOX SHELVES



BRUSHED
STEEL



BLACK



compact
line

C O M P A C T
L I N E

Linea di frigoriferi da banco a refrigerazione ventilata (No-frost), disponibile sia in versione a temperatura positiva (NFP) sia negativa (NFN).

Le dimensioni e l'ampia visibilità interna rendono la linea "compact" ideale per chi ha la necessità di esporre e conservare al meglio i propri prodotti anche in presenza di ridotti spazi espositivi.

- Il vano motore, avvolto da lastre in materiale plastico semi-trasparente è retroilluminato e può essere personalizzato con loghi scelti dal cliente.
- Telaio esterno in alluminio ossidato disponibile nei colori grigio e bronzo standard, nero, lucido ad effetto cromo oltre che verniciato a richiesta.
- Utilizzo di vetrate basso emissive a doppia camera a gas inerte e triplo vetro per serie NFN
- Interno dotato di illuminazione, contatto stop ventole su apertura porta, griglie cromate e verniciate, ripiani in vetro a richiesta e senza costi aggiuntivi.
- Defrost automatico, eliminazione della condensa per evaporazione. Sbrinatorio a gas caldo per vetrine della serie NFN, con resistenza elettrica per la serie NFP.

Ampia gamma di accessori e optional disponibili

Line of counter refrigerators with ventilated (No-Frost) refrigeration system

available in both positive temperature (NFP) and negative (NFN).

With its dimensions and internal visibility the " compact" line is ideal for those who need to display and store most of their products in reduced spaces.

- The engine compartment is covered with a semi-transparent plastic lighting box, that can be customized with clients' logos.
- External finish: anodized aluminum silver or bronze standard, black ,polished chrome effect as well as coated on demand.
- Using of low-e glass double compartment with inert gas and triple glass for NFN series
- Inside lighting , contact fans' stop when opened door, treated grid shelves or glass shelves upon request and without additional costs.
- Automatic Defrost, condensing water elimination. Defrost with use of hot gas for NFN series, with electrical resistance for NFP series.







Available wide range of accessories and options



FRIGORIFERI DA BANCO COUNTER REFRIGERATORS

460 X 550 X 1070 mm

LP 460

 NO FROST						
NFP	+10 / -5 °C	1	0,30	120	85 - 95	2.050,00 €
NFN	+5 / -25 °C	1	0,50	120	85 - 95	2.310,00 €

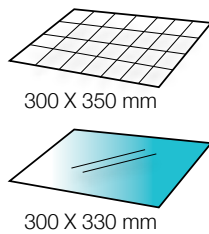

2 GRIGLIE
2 GRIDS
or
2 PIANI VETRO
2 GLASS SHELVES

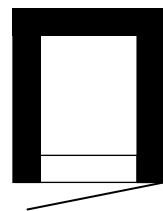







1 LATO ESPOSITIVO
1 GLAZED SIDE

FRIGORIFERI DA BANCO COUNTER REFRIGERATORS

670 X 550 X 1070 mm

LP 670

 NO FROST						
NFP	+10 / -5 °C	1	0,30	160	84 - 90	2.260,00 €
NFN	+5 / -25 °C	1	0,50	160	84 - 90	2.960,00 €

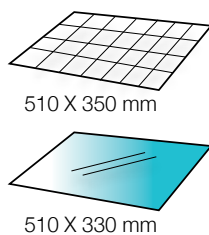



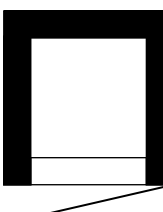



2 GRIGLIE
2 GRIDS
or
2 PIANI VETRO
2 GLASS SHELVES



1 LATO ESPOSITIVO
1 GLAZED SIDE

MAC 500 500 X 640 X 1070 mm FRIGORIFERI DA BANCO COUNTER REFRIGERATORS

 NO FROST						
NFP	+10 / -5 °C	1	0,30	134	86 - 102	2.920,00 €
NFN	+5 / -25 °C	1	0,50	134	86 - 102	3.970,00 €

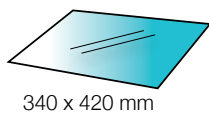
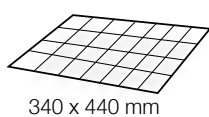



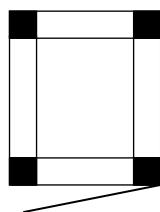



2 GRIGLIE
2 GRIDS
or
2 PIANI VETRO
2 GLASS SHELVES



4 LATI ESPOSITIVI
4 GLAZED SIDES

MAC 670 670 X 640 X 1070 mm FRIGORIFERI DA BANCO COUNTER REFRIGERATORS

 NO FROST						
NFP	+10 / -5 °C	1	0,30	190	100 - 115	2.920,00 €
NFN	+5 / -25 °C	1	0,50	190	100 - 115	3.970,00 €

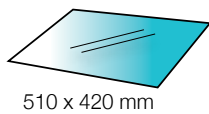
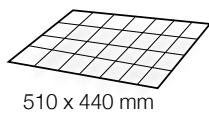

2 GRIGLIE
2 GRIDS
or
2 PIANI VETRO
2 GLASS SHELVES

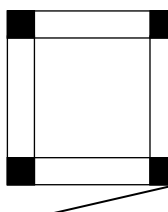

4 LATI ESPOSITIVI
4 GLAZED SIDES



lab line

L A B . L I N E

La linea 'Lab' viene incontro ai laboratori, non solo gelateria e pasticceria, che richiedono un prodotto che soddisfi le più comuni esigenze di conservazione e abbattimento dei prodotti.

La 'Lab' line si sviluppa attraverso dimensioni, allestimenti interni, tipologia di conservazione e materiali, che portano il numero di modelli disponibili a più di 50.

La linea 'Lab' è composta da armadi refrigerati a conservazione: positiva statica, positiva ventilata, negativa ventilata, abbattimento ventilato a de-frost automatico o manuale.

La linea 'Lab' mantenendo inalterate le prestazioni viene offerta in: lamiera plastificata, lamiera pre-rivestita effetto inox e acciaio inox.

La linea 'lab' al suo interno presenta allestimenti per gelateria, pasticceria, panificazione attraverso griglie porta vasche o assetti per teglie 60 x 40, GN 1/1, GN 2/1 o a richiesta dimensioni speciali.

La linea 'lab' offre inoltre la possibilità di avere l'unità condensante in remoto o condensata H2O per rendere così l'ambiente all'interno del laboratorio più confortevole.

The 'Lab' line meets the laboratories, ice cream shops and bakeries in particular, which require a cabinet that satisfies the most common needs of conservation and blasting of products.

It develops through dimensions, inner settings, materials and type of storage, choosing between more than 50 models.

The 'Lab' line consists of refrigerated cabinets for storage: static positive, positive ventilated, negative ventilated, blasting ventilated with automatic or manual de-frost.

Maintaining high performances the 'Lab' line is offered in: white skinplate, grey skinplate stainless steel effect and stainless steel.

The 'Lab' line can be fitted for ice cream pans, pastry, bakery through grid shelves or guides for trays 60 x 40 cm, GN 1/1, GN 2/1 or special sizes on demand.

The 'Lab' line also offers the possibility to have the remote condensing unit or H2O condensation system to have a more comfortable environment inside the laboratory.



670 X 640 X 1930 mm

4000

Icona	Icona	Icona	Icona	Icona	Icona	Icona	Icona
P	+2 / +10 °C	1	0,26	400	150 - 180	lam. plast.	2.320,00 €
P	+2 / +10 °C	1	0,26	400	150 - 180	acc. inox	2.890,00 €
NFP	+10 / -5 °C	1	0,40	400	150 - 180	lam. plast.	2.640,00 €
NFP	+10 / -5 °C	1	0,40	400	150 - 180	acc. inox	3.210,00 €
NFN	+5 / -25 °C	1	0,50	400	150 - 180	lam. plast.	3.020,00 €
NFN	+5 / -25 °C	1	0,50	400	150 - 180	acc. inox	3.630,00 €
NFA	-18 / -40 °C	1	1,50	400	150 - 180	lam. plast.	4.650,00 €
NFA	-18 / -40 °C	1	1,50	400	150 - 180	acc. inox	5.490,00 €

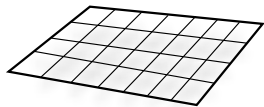

510 X 440 mm

4 GRIGLIE
4 GRIDS



AUTO



INOX



LAM. INOX



LAM. PLAST.

*modelli statici 1880 mm static model 1880 mm

*modelli NFA NFAN 1960 mm model NFA NFAN 1960 mm

670 X 640 X 1930 mm

4000 2T

Icona	Icona	Icona	Icona	Icona	Icona	Icona	Icona
NFP	+10 / -5 °C	1	0,40	340	150 - 180	lam. plast.	3.130,00 €
NFP	+10 / -5 °C	1	0,40	340	150 - 180	acc. inox	3.870,00 €
CB	+5 / -25 °C +10 / -5 °C	1	0,80	340	150 - 180	lam. plast.	3.550,00 €
CB	+5 / -25 °C +10 / -5 °C	1	0,80	340	150 - 180	acc. inox	4.360,00 €

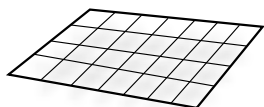

510 X 440 mm

4 GRIGLIE
4 GRIDS



AUTO



INOX



LAM. INOX



LAM. PLAST.

*modelli statici 1880 mm static model 1880 mm

7000

1320 X 640 X 1930 mm

STATIC	NO Frost	Thermometer	Energy	LT	KG	Star	€
P	+2 / +10 °C	1	0,52	855	230 - 250	lam. plast.	3.490,00 €
P	+2 / +10 °C	1	0,52	855	230 - 250	acc. inox	4.490,00 €
NFP	+10 / -5 °C	1	0,50	855	230 - 250	lam. plast.	4.210,00 €
NFP	+10 / -5 °C	1	0,50	855	230 - 250	acc. inox	5.290,00 €
NFN	+5 / -25 °C	1	1,00	855	230 - 250	lam. plast.	4.780,00 €
NFN	+5 / -25 °C	1	1,00	855	230 - 250	acc. inox	5.970,00 €

*modelli statici 1880 mm static model 1880 mm

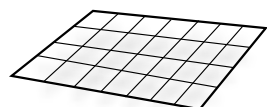

1160 X 440 mm

4 GRIGLIE
4 GRIDS



AUTO



INOX



LAM. INOX



LAM. PLAST.



8000

1320 X 640 X 1930 mm

STATIC	NO Frost	Thermometer	Energy	LT	KG	Star	€
P	+2 / +10 °C	2	0,80	740	230 - 250	lam. plast.	4.060,00 €
P	+2 / +10 °C	2	0,80	740	230 - 250	acc. inox	5.240,00 €
NFP	+10 / -5 °C	2	0,80	740	230 - 250	lam. plast.	5.090,00 €
NFP	+10 / -5 °C	2	0,80	740	230 - 250	acc. inox	6.180,00 €
NFN	+5 / -25 °C	2	1,00	740	230 - 250	lam. plast.	5.550,00 €
NFN	+5 / -25 °C	2	1,00	740	230 - 250	acc. inox	6.600,00 €
NFA	-18 / -40 °C	2	3,00	740	230 - 250	lam. plast.	8.380,00 €
NFA	-18 / -40 °C	2	3,00	740	230 - 250	acc. inox	9.950,00 €
CB	+5 / -25 °C +10 / -5 °C	2	0,90	740	230 - 250	lam. plast.	5.370,00 €
CB	+5 / -25 °C +10 / -5 °C	2	0,90	740	230 - 250	acc. inox	6.400,00 €

*modelli statici 1880 mm static model 1880 mm

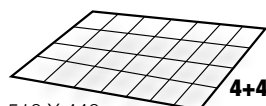

510 X 440 mm

4+4 GRIGLIE
4+4 GRIDS



AUTO



INOX



LAM. INOX











LAM. PLAST.



1320 X 640 X 1930 mm

8000 4T

							
NFP	+10 / -5 °C	2	0,80	680	230 - 250	lam. plast.	6.300,00 €
NFP	+10 / -5 °C	2	0,80	680	230 - 250	acc. inox	7.860,00 €
CB	+5 / -25 °C +10 / -5 °C	2	1,60	680	230 - 250	lam. plast.	7.270,00 €
CB	+5 / -25 °C +10 / -5 °C	2	1,60	680	230 - 250	acc. inox	8.870,00 €

*modelli statici 1880 mm static model 1880 mm

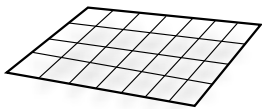

510 X 440 mm

2+2+2+2 GRIGLIE
2+2+2+2 GRIDS



AUTO



INOX



LAM. INOX











LAM. PLAST.



900 X 640 X 1930 mm

9000

							
P	+2 / +10 °C	1	0,28	600	180 - 200	lam. plast.	2.800,00 €
P	+2 / +10 °C	1	0,28	600	180 - 200	acc. inox	3.460,00 €
NFP	+10 / -5 °C	1	0,40	600	180 - 200	lam. plast.	2.970,00 €
NFP	+10 / -5 °C	1	0,40	600	180 - 200	acc. inox	3.710,00 €
NFN	+5 / -25 °C	1	0,50	600	180 - 200	lam. plast.	3.470,00 €
NFN	+5 / -25 °C	1	0,50	600	180 - 200	acc. inox	4.140,00 €

*modelli statici 1880 mm static model 1880 mm

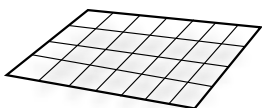

740 X 440 mm

4 GRIGLIE
4 GRIDS



AUTO



INOX



LAM. INOX









LAM. PLAST.



9018

1780 X 640 X 1930 mm

 NO FROST							€
NFP	+10 / -5 °C	1	0,80	1200	310 - 330	lam. plast.	5.490,00 €
NFP	+10 / -5 °C	1	0,80	1200	310 - 330	acc. inox	6.830,00 €
NFN	+5 / -25 °C	2	1,00	1200	310 - 330	lam. plast.	6.470,00 €
NFN	+5 / -25 °C	2	1,00	1200	310 - 330	acc. inox	7.730,00 €
CB	+5 / -25 °C +10 / -5 °C	2	0,90	1200	310 - 330	lam. plast.	5.960,00 €
CB	+5 / -25 °C +10 / -5 °C	2	0,90	1200	310 - 330	acc. inox	7.380,00 €

*modelli statici 1880 mm static model 1880 mm

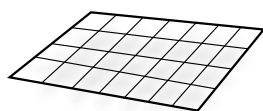

740 X 440 mm

4+4 GRIGLIE
4+4 GRIDS



AUTO



INOX









LAM. INOX



LAM. PLAST.

9501

1320 X 890 X 1930 mm

 NO FROST							€
NFP	+10 / -5 °C	1	0,80	1200	330 - 350	lam. plast.	4.820,00 €
NFP	+10 / -5 °C	1	0,80	1200	330 - 350	acc. inox	5.720,00 €
NFN	+5 / -25 °C	1	1,40	1200	330 - 350	lam. plast.	5.590,00 €
NFN	+5 / -25 °C	1	1,40	1200	330 - 350	acc. inox	6.660,00 €

*modelli statici 1880 mm static model 1880 mm

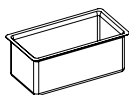

CAPACITA' CAPACITY
48+48 165 X 120 X 360 mm

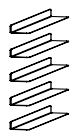

in alternativa
22+22 x GN 2/1

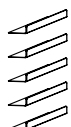

NFP 4+4 GRIGLIE **NFP 4+4 GRIDS**
NFN 7+7 GRIGLIE **NFN 7+7 GRIDS**

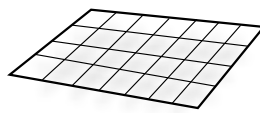

510 X 680 mm



AUTO



INOX



LAM. INOX



LAM. PLAST.

1630 X 890 X 1930 mm

9502

NO FROST	Thermometer	Recycling	KW	LT	KG	Star	€
NFP	+10 / -5 °C	1	1,00	1600	340 - 365	lam. plast.	5.810,00 €
NFP	+10 / -5 °C	1	1,00	1600	340 - 365	acc. inox	6.950,00 €
NFN	+5 / -25 °C	1	1,50	1600	340 - 365	lam. plast.	6.430,00 €
NFN	+5 / -25 °C	1	1,50	1600	340 - 365	acc. inox	7.720,00 €

*modelli statici 1880 mm static model 1880 mm

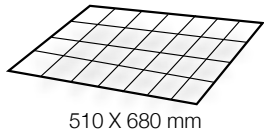

510 X 680 mm

NFP 4+4 GRIGLIE **NFP 4+4 GRIDS**
NFN 7+7 GRIGLIE **NFN 7+7 GRIDS**



AUTO



INOX



LAM. INOX



LAM. PLAST.



760 X 1010 X 1930 mm

5002

NO FROST	Thermometer	Recycling	KW	LT	KG	Star	€
NFP	+10 / -5 °C	1	0,80	950	210 - 230	lam. plast.	4.170,00 €
NFP	+10 / -5 °C	1	0,80	950	210 - 230	acc. inox	4.860,00 €
NFN	+5 / -25 °C	1	1,00	950	210 - 230	lam. plast.	4.930,00 €
NFN	+5 / -25 °C	1	1,00	950	210 - 230	acc. inox	5.700,00 €
NFNA	-18 / -40 °C	2	3,00	950	210 - 230	lam. plast.	7.820,00 €
NFNA	-18 / -40 °C	2	3,00	950	210 - 230	acc. inox	9.120,00 €
FL	+30 / -5 °C	1	0,80	950	210 - 230	lam. plast.	4.550,00 €
FL	+30 / -5 °C	1	0,80	950	210 - 230	acc. inox	5.280,00 €

*modelli NFA NFNA 1960 mm NFA NFNA model 1960 mm



22+22 600 X 400 mm
22 600 X 800 mm

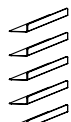

AUTO



INOX



LAM. INOX









LAM. PLAST.



10000

1500 X 640 X 1930 mm

							€
NFP	+10 / -5 °C	2	0,80	900	310 - 330	lam. plast.	5.380,00 €
NFP	+10 / -5 °C	2	0,80	900	310 - 330	acc. inox	6.650,00 €
NFN	+5 / -25 °C	2	1,00	900	310 - 330	lam. plast.	5.890,00 €
NFN	+5 / -25 °C	2	1,00	900	310 - 330	acc. inox	7.110,00 €
NFA	-18 / -40 °C	2	3,00	900	310 - 330	lam. plast.	9.380,00 €
NFA	-18 / -40 °C	2	3,00	900	310 - 330	acc. inox	11.090,00 €
CB	+5 / -25 °C +10 / -5 °C	2	0,90	900	310 - 330	lam. plast.	5.580,00 €
CB	+5 / -25 °C +10 / -5 °C	2	0,90	900	310 - 330	acc. inox	6.770,00 €

*modelli NFA NFNA 1960 mm NFA NFNA model 1960 mm

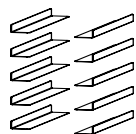

600 X 400 mm

**standard
22+22**

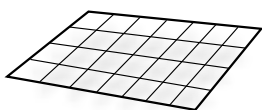

600 X 440 mm

**in alternativa
4+4 GRIGLIE
4+4 GRIDS**



AUTO



INOX









LAM. INOX



LAM. PLAST.

10000 FL

1500 X 640 X 1930 mm

							€
NFP	+10 / -5 °C	2	0,80	900	310 - 330	lam. plast.	6.210,00 €
NFP	+10 / -5 °C	2	0,80	900	310 - 330	acc. inox	7.580,00 €
NFN	+5 / -25 °C	2	1,00	900	310 - 330	lam. plast.	6.440,00 €
NFN	+5 / -25 °C	2	1,00	900	310 - 330	acc. inox	7.840,00 €
FL	+30 / -5 °C	2	0,80	900	310 - 330	lam. plast.	6.630,00 €
FL	+30 / -5 °C	2	0,80	900	310 - 330	acc. inox	8.070,00 €

*modelli statici 1880 mm static model 1880 mm

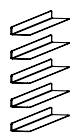

600 X 400 mm

**standard
22+22**

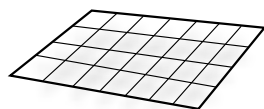
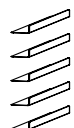

600 X 440 mm

**alternativa
4+4 GRIGLIE 4+4 GRIDS**



AUTO



INOX









LAM. INOX



LAM. PLAST.

1320 X 890 X 1930 mm

10010

 NO FROST							€
NFP	+10 / -5 °C	2	0,80	1300	340 - 360	lam. plast.	5.610,00 €
NFP	+10 / -5 °C	2	0,80	1300	340 - 360	acc. inox	6.710,00 €
NFN	+5 / -25 °C	2	1,00	1300	340 - 360	lam. plast.	6.630,00 €
NFN	+5 / -25 °C	2	1,00	1300	340 - 360	acc. inox	7.860,00 €
NFNA	-18 / -40 °C	4	6,00	1300	340 - 360	lam. plast.	11.220,00 €
NFNA	-18 / -40 °C	4	6,00	1300	340 - 360	acc. inox	13.530,00 €
CB	+5 / -25 °C +10 / -5 °C	2	0,90	1300	340 - 360	lam. plast.	6.210,00 €
CB	+5 / -25 °C +10 / -5 °C	2	0,90	1300	340 - 360	acc. inox	7.370,00 €



*modelli NFA NFNA 1960 mm NFA NFNA model 1960 mm

CAPACITA' CAPACITY
48+48
165 X 120 X 360 mm



in alternativa
22+22 x GN 2/1



NFP 4+4 GRIGLIE NFP 4+4 GRIDS
NFN 7+7 GRIGLIE NFN 7+7 GRIDS

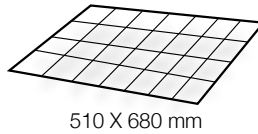

510 X 680 mm



INOX









LAM. INOX



LAM. PLAST.

1320 X 890 X 1930 mm

10010 4T

 NO FROST							€
NFP	+10 / -5 °C	4	1,00	1000	340 - 360	lam. plast.	6.750,00 €
NFP	+10 / -5 °C	4	1,00	1000	340 - 360	acc. inox	8.540,00 €
CB	+5 / -25 °C +10 / -5 °C	4	2,00	1000	340 - 360	lam. plast.	8.270,00 €
CB	+5 / -25 °C +10 / -5 °C	4	2,00	1000	340 - 360	acc. inox	10.080,00 €
CBA	+5 / -25 °C -18 / -40 °C	4	4,00	1000	340 - 360	lam. plast.	9.920,00 €
CBA	+5 / -25 °C -18 / -40 °C	4	4,00	1000	340 - 360	acc. inox	12.090,00 €



*modelli statici 1880 mm static model 1880 mm

CAPACITA' CAPACITY
18+18+18+18
165 X 120 X 360 mm

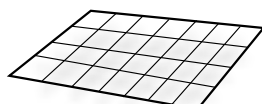

510 X 680 mm

NFP 4+4 GRIGLIE NFP 4+4 GRIDS
NFN 7+7 GRIGLIE NFN 7+7 GRIDS



AUTO



INOX











LAM. INOX



LAM. PLAST.

5010

670 X 890 X 1930 mm

 NO FROST							
NFP	+10 / -5 °C	1	0,40	650	195 - 209	lam. plast.	2.980,00 €
NFP	+10 / -5 °C	1	0,40	650	195 - 209	acc. inox	3.510,00 €
NFN	+5 / -25 °C	1	0,50	650	195 - 209	lam. plast.	3.400,00 €
NFN	+5 / -25 °C	1	0,50	650	195 - 209	acc. inox	4.040,00 €
NFNA	-18 / -40 °C	2	3,00	650	195 - 209	lam. plast.	6.630,00 €
NFNA	-18 / -40 °C	2	3,00	650	195 - 209	acc. inox	7.920,00 €
NFN/S	-5 / -35 °C	1	1,50	650	195 - 209	lam. plast.	3.990,00 €
NFN/S	-5 / -35 °C	1	1,50	650	195 - 209	acc. inox	4.750,00 €

*modelli NFA NFNA 1960 mm NFA NFNA model 1960 mm

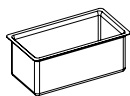

CAPACITA' CAPACITY
48 165 X 120 X 360 mm



in alternativa
22 x GN 2/1

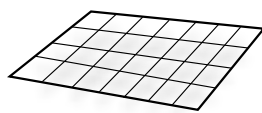
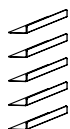

510 X 680 mm

NFP 4 GRIGLIE NFP 4 GRIDS
NFN 7 GRIGLIE NFN 7 GRIDS



AUTO



INOX











LAM. INOX



LAM. PLAST.

5010 2T

670 X 890 X 1930 mm

 NO FROST							
NFP	+10 / -5 °C	1	0,50	500	195 - 209	lam. plast.	3.760,00 €
NFP	+10 / -5 °C	1	0,50	500	195 - 209	acc. inox	4.600,00 €
CB	+5 / -25 °C +10 / -5 °C	1	1,00	500	195 - 209	lam. plast.	4.270,00 €
CB	+5 / -25 °C +10 / -5 °C	1	1,00	500	195 - 209	acc. inox	5.160,00 €
CBA	+5 / -25 °C -18 / -40 °C	2	2,00	500	195 - 209	lam. plast.	5.120,00 €
CBA	+5 / -25 °C -18 / -40 °C	2	2,00	500	195 - 209	acc. inox	6.190,00 €

*modelli statici 1880 mm static model 1880 mm

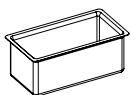

CAPACITA' CAPACITY
18+18
165 X 120 X 360 mm

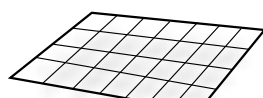

510 X 680 mm

2+2 GRIGLIE
2+2 GRIDS



AUTO



INOX



LAM. INOX











LAM. PLAST.



825 X 890 X 1930 mm

5020

							
NFP	+10 / -5 °C	1	0,40	800	200 - 210	lam. plast.	3.300,00 €
NFP	+10 / -5 °C	1	0,40	800	200 - 210	acc. inox	3.830,00 €
NFN	+5 / -25 °C	1	0,70	800	200 - 210	lam. plast.	3.900,00 €
NFN	+5 / -25 °C	1	0,70	800	200 - 210	acc. inox	4.480,00 €
NFNA	-18 / -40 °C	2	4,00	800	200 - 210	lam. plast.	7.430,00 €
NFNA	-18 / -40 °C	2	4,00	800	200 - 210	acc. inox	8.660,00 €

*modelli NFA NFNA 1960 mm NFA NFNA model 1960 mm

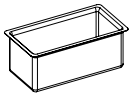

CAPACITA' CAPACITY
64 165 X 120 X 360 mm

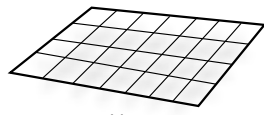

665 X 680 mm

NFP 4 GRIGLIE NFP 4 GRIDS
NFN 7 GRIGLIE NFN 7 GRIDS



AUTO



INOX











LAM. INOX



LAM. PLAST.

950 X 890 X 1930 mm

5030

							
NFP	+10 / -5 °C	1	0,40	900	211 - 225	lam. plast.	3.830,00 €
NFP	+10 / -5 °C	1	0,40	900	211 - 225	acc. inox	4.370,00 €
NFN	+5 / -25 °C	1	0,70	900	211 - 225	lam. plast.	4.460,00 €
NFN	+5 / -25 °C	1	0,70	900	211 - 225	acc. inox	5.150,00 €
NFNA	-18 / -40 °C	2	3,00	900	211 - 225	lam. plast.	8.500,00 €
NFNA	-18 / -40 °C	2	3,00	900	211 - 225	acc. inox	9.960,00 €

*modelli NFA NFNA 1960 mm NFA NFNA model 1960 mm

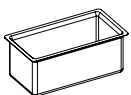

CAPACITA' CAPACITY
48 250 X 120 X 360 mm

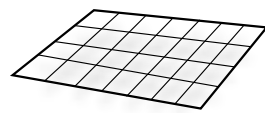

740 X 680 mm

NFP 4 GRIGLIE NFP 4 GRIDS
NFN 7 GRIGLIE NFN 7 GRIDS



AUTO



INOX











LAM. INOX



LAM. PLAST.

5010 2T HI 670 X 890 X 2250 mm

							
CBA	+5 / -25 °C -18 / -40 °C	2	2,00	620	195 - 209	lam. plast.	6.220,00 €
CBA	+5 / -25 °C -18 / -40 °C	2	2,00	620	195 - 209	acc. inox	7.090,00 €

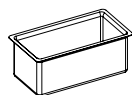

**NFN 36
+
NFA 12**

CAPACITA' CAPACITY
48+48 165 X 120 X 360 mm

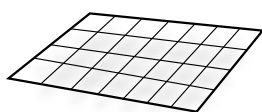

510 X 680 mm

5+1 GRIGLIE 5+1 GRIDS



AUTO



INOX











LAM. INOX



LAM. PLAST.

5010 HI 670 X 890 X 2250 mm

							
NFP	+10 / -5 °C	1	0,40	720	195 - 209	lam. plast.	3.190,00 €
NFP	+10 / -5 °C	1	0,40	720	195 - 209	acc. inox	3.800,00 €
NFN	+5 / -25 °C	1	0,80	720	195 - 209	lam. plast.	3.740,00 €
NFN	+5 / -25 °C	1	0,80	720	195 - 209	acc. inox	4.440,00 €
NFNA	-18 / -40 °C	2	3,00	720	195 - 209	lam. plast.	7.320,00 €
NFNA	-18 / -40 °C	2	3,00	720	195 - 209	acc. inox	8.740,00 €
NFN/S	-5 / -35 °C	1	1,50	720	195 - 209	lam. plast.	4.370,00 €
NFN/S	-5 / -35 °C	1	1,50	720	195 - 209	acc. inox	5.190,00 €

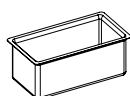

CAPACITA' CAPACITY
60 165 X 120 X 360 mm

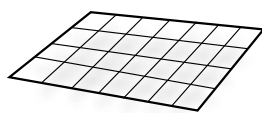

510 X 680 mm

NFP 7 GRIGLIE NFP 7 GRIDS
NFN 9 GRIGLIE NFN 9 GRIDS

*modelli statici 1880 mm
static model 1880 mm



AUTO



INOX









LAM. INOX



LAM. PLAST.

670 X 640 X 1250 mm

0040

 NO FROST							€
NFP	+10 / -5 °C	1	0,30	210	85 - 95	lam. plast.	2.240,00 €
NFP	+10 / -5 °C	1	0,30	210	85 - 95	acc. inox	2.750,00 €
NFN	+5 / -25 °C	1	0,40	210	85 - 95	lam. plast.	2.580,00 €
NFN	+5 / -25 °C	1	0,40	210	85 - 95	acc. inox	3.080,00 €
NFA	-18 / -40 °C	1	1,20	210	85 - 95	lam. plast.	3.960,00 €
NFA	-18 / -40 °C	1	1,20	210	85 - 95	acc. inox	4.690,00 €

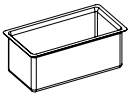

CAPACITA' CAPACITY
9 165 X 120 X 360 mm

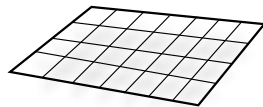

510 X 440 mm
2 GRIGLIE 2 GRIDS



AUTO



INOX









LAM. INOX



LAM. PLAST.

760 X 640 X 1250 mm

0050

 NO FROST							€
NFP	+10 / -5 °C	1	0,30	260	90 - 100	lam. plast.	2.450,00 €
NFP	+10 / -5 °C	1	0,30	260	90 - 100	acc. inox	3.030,00 €
NFN	+5 / -25 °C	1	0,40	260	90 - 100	lam. plast.	2.770,00 €
NFN	+5 / -25 °C	1	0,40	260	90 - 100	acc. inox	3.270,00 €
NFA	-18 / -40 °C	1	1,30	260	90 - 100	lam. plast.	4.610,00 €
NFA	-18 / -40 °C	1	1,30	260	90 - 100	acc. inox	5.450,00 €
FL	+30 / -5 °C	1	0,30	260	90 - 100	lam. plast.	3.150,00 €
FL	+30 / -5 °C	1	0,30	260	90 - 100	acc. inox	3.830,00 €



9 600 X 400 mm

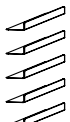

0

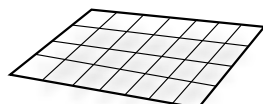

740 X 440 mm
2 GRIGLIE 2 GRIDS



AUTO



INOX









LAM. INOX



LAM. PLAST.

0090

900 X 640 X 1250 mm

 NO FROST							€
NFP	+10 / -5 °C	1	0,40	350	95 - 105	lam. plast.	2.540,00 €
NFP	+10 / -5 °C	1	0,40	350	95 - 105	acc. inox	3.1400,00 €
NFN	+5 / -25 °C	1	0,50	350	95 - 105	lam. plast.	2.940,00 €
NFN	+5 / -25 °C	1	0,50	350	95 - 105	acc. inox	3.540,00 €
NFA	-18 / -40 °C	1	1,50	350	95 - 105	lam. plast.	5.260,00 €
NFA	-18 / -40 °C	1	1,50	350	95 - 105	acc. inox	6.250,00 €

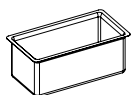

CAPACITA' CAPACITY
12 165 X 120 X 360 mm

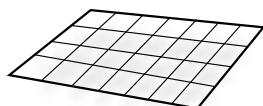

740 X 440 mm

2 GRIGLIE 2 GRIDS



AUTO



INOX









LAM. INOX



LAM. PLAST.

5000

760 X 640 X 1930 mm

 NO FROST							€
NFP	+10 / -5 °C	1	0,40	500	180 - 200	lam. plast.	2.860,00 €
NFP	+10 / -5 °C	1	0,40	500	180 - 200	acc. inox	3.590,00 €
NFN	+5 / -25 °C	1	0,50	500	180 - 200	lam. plast.	3.240,00 €
NFN	+5 / -25 °C	1	0,50	500	180 - 200	acc. inox	3.870,00 €
NFA	-18 / -40 °C	1	1,50	500	180 - 200	lam. plast.	5.410,00 €
NFA	-18 / -40 °C	1	1,50	500	180 - 200	acc. inox	6.420,00 €
FL	+30 / -5 °C	1	0,40	500	180 - 200	lam. plast.	3.720,00 €
FL	+30 / -5 °C	1	0,40	500	180 - 200	acc. inox	4.480,00 €

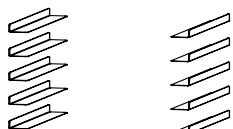

600 X 400 mm

standard
22

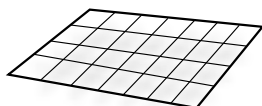

600 X 440 mm

in alternativa
4 GRIGLIE 4 GRIDS



AUTO



INOX



LAM. INOX



LAM. PLAST.

*modelli NFA NFNA 1960 mm NFA NFNA model 1960 mm

760 X 1100 X 2280 mm

PANE 1

NO FROST	Thermometer	Defrost	KW	LT	KG	Star	€
FL	+30 / -5 °C	1	1,50	870	195 - 209	lam. plast.	7.180,00 €
FL	+30 / -5 °C	1	1,50	870	195 - 209	acc. inox	7.620,00 €

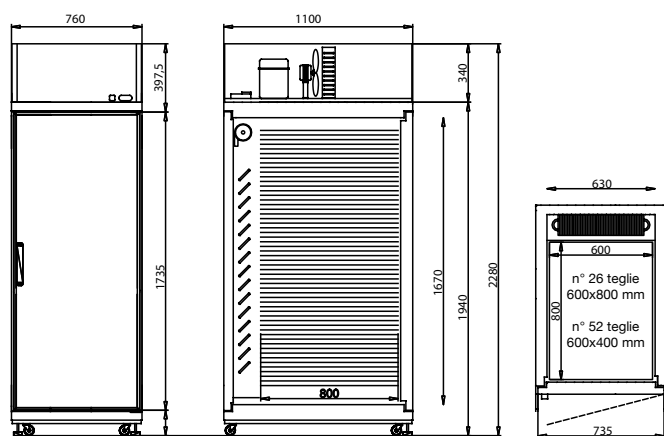

760 X 700 X 2280 mm



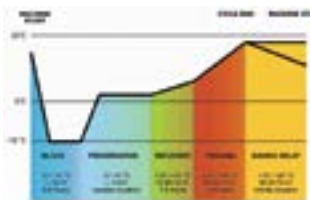
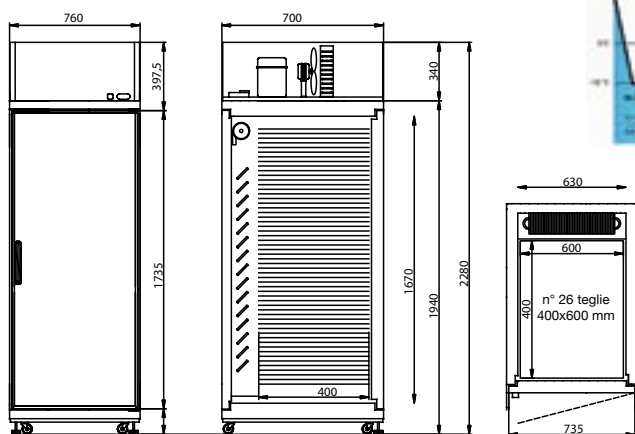

PANE 2

NO FROST	Thermometer	Defrost	KW	LT	KG	Star	€
FL	+30 / -5 °C	1	1,00	450	125 - 140	lam. plast.	5.860,00 €
FL	+30 / -5 °C	1	1,00	450	125 - 140	acc. inox	6.290,00 €



TK FAST 5T

760 X 700 X 850 mm

 MANUAL			
4 CICLI 4 CICLES	lam. plast.	4.280,00 €	

ABBATTIMENTO POSITIVO & SURGELAZIONE

POSITIVE CHILLING & DEEP-FREEZING



530 X 325 mm
or
600 X 400 mm
5 GN 1/1-E

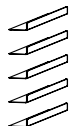

360 X 165 X 120 mm
**CAPACITA' CAPACITY
6 X 5 LT.**

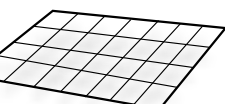
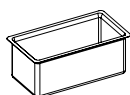

**OPTIONAL
1 GRIGLIA 1 GRID**







LAM. PLAST.



TK FAST 10T

790 X 780 X 1630 mm

 MANUAL			
4 CICLI 4 CICLES	lam. plast.	7.430,00 €	

ABBATTIMENTO POSITIVO & SURGELAZIONE

POSITIVE CHILLING & DEEP-FREEZING



530 X 325 mm
or
600 X 400 mm
10 GN 1/1-E

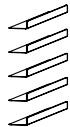

360 X 165 X 120 mm
**CAPACITA' CAPACITY
15 X 5 LT.**

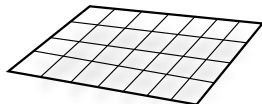
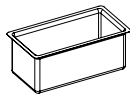

**OPTIONAL
4 GRIGLIE 4 GRIDS**







LAM. PLAST.



TK FAST 15T

790 X 780 X 1980 mm

 MANUAL			
4 CICLI 4 CICLES	lam. plast.	9.290,00 €	

ABBATTIMENTO POSITIVO & SURGELAZIONE

POSITIVE CHILLING & DEEP-FREEZING



530 X 325 mm
or
600 X 400 mm
15 GN 1/1-E

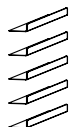

360 X 165 X 120 mm
**CAPACITA' CAPACITY
21 X 5 LT.**

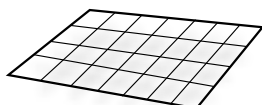
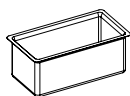

**OPTIONAL
6 GRIGLIE 6 GRIDS**



LAM. PLAST.





H O T . L I N E

2400 HOT

460 X 640 X 1910 mm *glassy line*

TEMP.	+25 / +75 °C	CAP. (LT)	225	PREZZO PRICE	3.220,00 €
-------	--------------	-----------	-----	--------------	------------

4400 HOT

670 X 640 X 1910 mm *glassy line*

TEMP.	+25 / +75 °C	CAP. (LT)	430	PREZZO PRICE	3.840,00 €
-------	--------------	-----------	-----	--------------	------------

4401 HOT

670 X 640 X 1910 mm *glassy line*

TEMP.	+25 / +75 °C	CAP. (LT)	430	PREZZO PRICE	4.280,00 €
-------	--------------	-----------	-----	--------------	------------

9400 HOT

900 X 640 X 1910 mm *glassy line*

TEMP.	+25 / +75 °C	CAP. (LT)	595	PREZZO PRICE	5.180,00 €
-------	--------------	-----------	-----	--------------	------------

R26 HOT

760 X 760 X 1910 mm *r26 LINE*

TEMP.	+25 / +75 °C	CAP. (LT)	530	PREZZO PRICE	6.910,00 €
-------	--------------	-----------	-----	--------------	------------

MAC 500 HOT

500 X 640 X 1078 mm *compact line*

TEMP.	+25 / +75 °C	CAP. (LT)	134	PREZZO PRICE	3.110,00 €
-------	--------------	-----------	-----	--------------	------------

MAC 670 HOT

670 X 640 X 1078 mm *compact line*

TEMP.	+25 / +75 °C	CAP. (LT)	190	PREZZO PRICE	3.110,00 €
-------	--------------	-----------	-----	--------------	------------

CIELO 76 HOT

760 X 640 X 1230 mm *CIELO LINE*

TEMP.	+25 / +75 °C	CAP. (LT)	190	PREZZO PRICE	5.550,00 €
-------	--------------	-----------	-----	--------------	------------

CIELO 90 HOT

900 X 640 X 1230 mm *CIELO LINE*

TEMP.	+25 / +75 °C	CAP. (LT)	260	PREZZO PRICE	6.530,00 €
-------	--------------	-----------	-----	--------------	------------

CIELO 132 HOT

1320 X 640 X 1230 mm *CIELO LINE*

TEMP.	+25 / +75 °C	CAP. (LT)	260	PREZZO PRICE	7.270,00 €
-------	--------------	-----------	-----	--------------	------------



*bar counter
line*



BARCOUNTER
LINE

bar counter line



900 X 550 X 885 mm

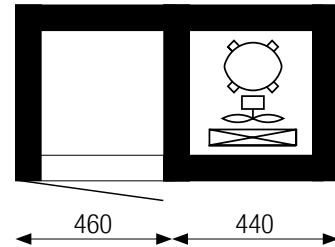

0 SBM

 NO FROST			€
NFP	+10 / -5 °C	lam. plast.	2.170,00 €
NFP	+10 / -5 °C	acc. inox	2.590,00 €
NFN	+5 / -25 °C	lam. plast.	2.320,00 €
NFN	+5 / -25 °C	acc. inox	2.710,00 €



1110 X 550 X 885 mm

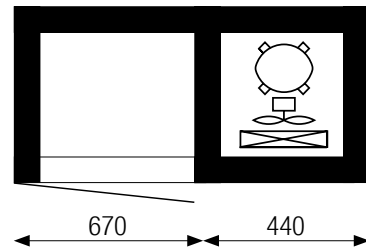

1 SBM

 NO FROST			€
NFP	+10 / -5 °C	lam. plast.	2.530,00 €
NFP	+10 / -5 °C	acc. inox	2.940,00 €
NFN	+5 / -25 °C	lam. plast.	3.010,00 €
NFN	+5 / -25 °C	acc. inox	3.490,00 €



1340 X 550 X 885 mm

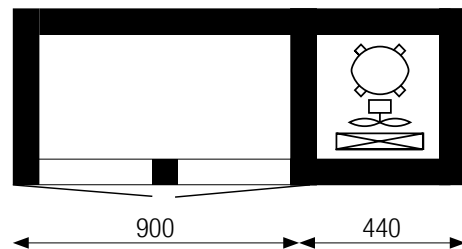

2 SBM

 NO FROST			€
NFP	+10 / -5 °C	lam. plast.	3.570,00 €
NFP	+10 / -5 °C	acc. inox	4.040,00 €
NFN	+5 / -25 °C	lam. plast.	4.040,00 €
NFN	+5 / -25 °C	acc. inox	4.580,00 €



1340 X 550 X 885 mm

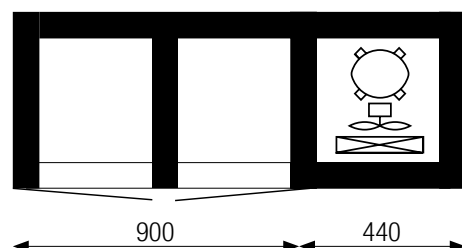

2 SBM-2T

 NO FROST			€
CB	+5 / -25 °C +10 / -5 °C	lam. plast.	4.440,00 €
CB	+5 / -25 °C +10 / -5 °C	acc. inox	5.050,00 €



3 SBM

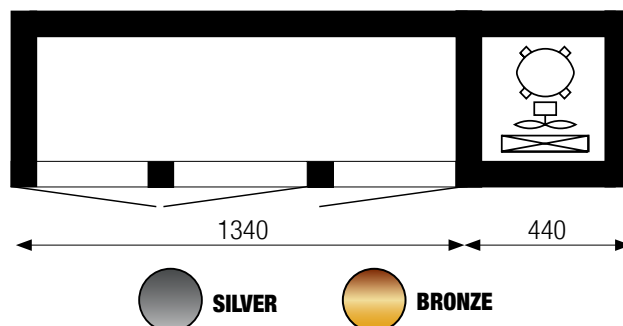

1780 X 550 X 885 mm

 NO FROST			€
NFP	+10 / -5 °C	lam. plast.	4.040,00 €
NFP	+10 / -5 °C	acc. inox	4.720,00 €
NFN	+5 / -25 °C	lam. plast.	4.370,00 €
NFN	+5 / -25 °C	acc. inox	5.130,00 €



3 SBM-2T

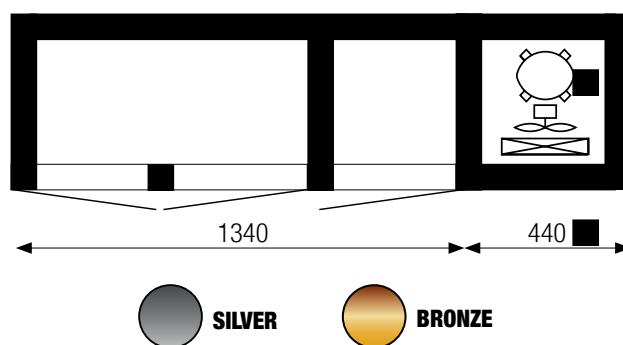

1780 X 550 X 885 mm

 NO FROST			€
CB	+5 / -25 °C +10 / -5 °C	lam. plast.	5.020,00 €
CB	+5 / -25 °C +10 / -5 °C	acc. inox	5.870,00 €



4 SBM

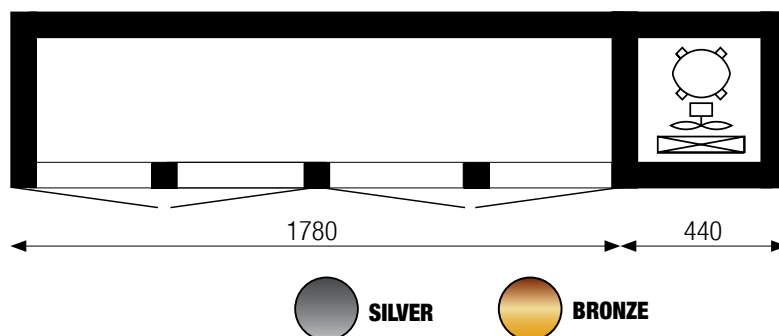

2220 X 550 X 885 mm

 NO FROST			€
NFP	+10 / -5 °C	lam. plast.	5.310,00 €
NFP	+10 / -5 °C	acc. inox	6.240,00 €
NFN	+5 / -25 °C	lam. plast.	6.010,00 €
NFN	+5 / -25 °C	acc. inox	6.680,00 €



4 SBM-2T

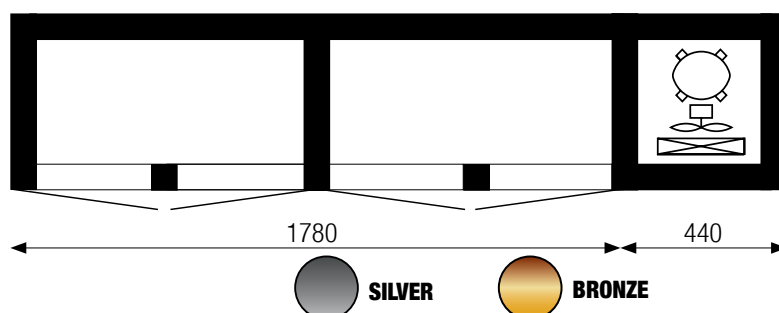

2220 X 550 X 885 mm

 NO FROST			€
CB	+5 / -25 °C +10 / -5 °C	lam. plast.	6.340,00 €
CB	+5 / -25 °C +10 / -5 °C	acc. inox	7.420,00 €



900 X 550 X 885 mm

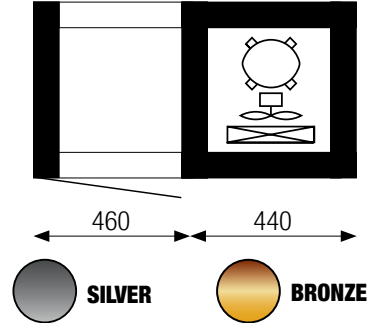

0 SBP

 NO FROST			€
NFP	+10 / -5 °C	lam. plast.	2.320,00 €
NFP	+10 / -5 °C	acc. inox	2.730,00 €
NFN	+5 / -25 °C	lam. plast.	2.780,00 €
NFN	+5 / -25 °C	acc. inox	3.230,00 €



1110 X 550 X 885 mm

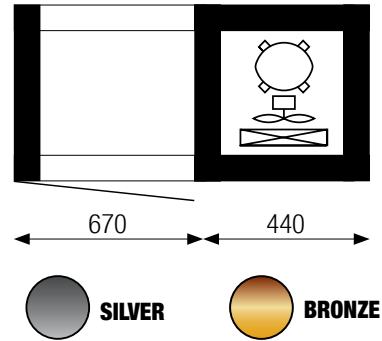

1 SBP

 NO FROST			€
NFP	+10 / -5 °C	lam. plast.	2.730,00 €
NFP	+10 / -5 °C	acc. inox	3.200,00 €
NFN	+5 / -25 °C	lam. plast.	3.520,00 €
NFN	+5 / -25 °C	acc. inox	4.150,00 €



1340 X 550 X 885 mm

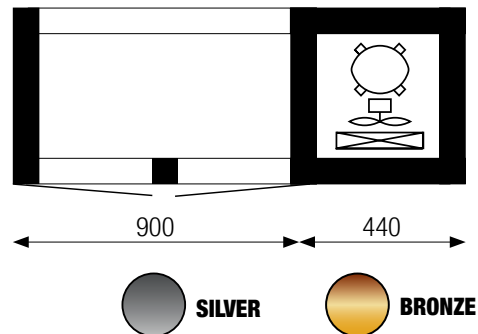

2 SBP

 NO FROST			€
NFP	+10 / -5 °C	lam. plast.	3.870,00 €
NFP	+10 / -5 °C	acc. inox	4.460,00 €
NFN	+5 / -25 °C	lam. plast.	4.600,00 €
NFN	+5 / -25 °C	acc. inox	5.410,00 €



1340 X 550 X 885 mm

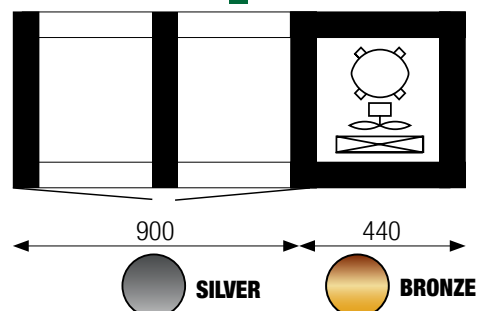

2 SBP-2T

 NO FROST			€
CB	+5 / -25 °C +10 / -5 °C	lam. plast.	4.600,00 €
CB	+5 / -25 °C +10 / -5 °C	acc. inox	5.410,00 €



3 SBP

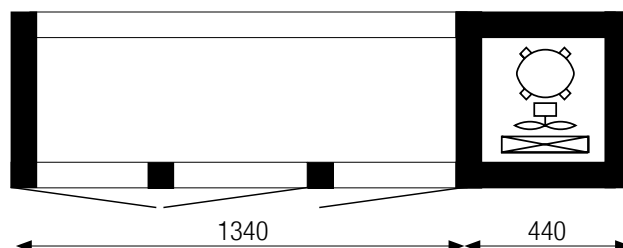

1780 X 550 X 885 mm

 NO FROST			€
NFP	+10 / -5 °C	lam. plast.	4.390,00 €
NFP	+10 / -5 °C	acc. inox	5.150,00 €
NFN	+5 / -25 °C	lam. plast.	5.260,00 €
NFN	+5 / -25 °C	acc. inox	6.160,00 €



3 SBP-2T

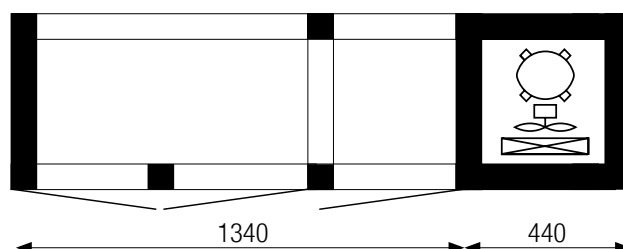

1780 X 550 X 885 mm

 NO FROST			€
CB	+5 / -25 °C +10 / -5 °C	lam. plast.	5.720,00 €
CB	+5 / -25 °C +10 / -5 °C	acc. inox	6.660,00 €



4 SBP

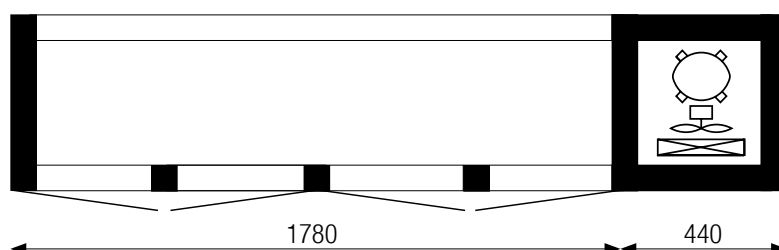

2220 X 550 X 885 mm

 NO FROST			€
NFP	+10 / -5 °C	lam. plast.	6.350,00 €
NFP	+10 / -5 °C	acc. inox	7.470,00 €
NFN	+5 / -25 °C	lam. plast.	8.000,00 €
NFN	+5 / -25 °C	acc. inox	9.330,00 €



4 SBP-2T

2220 X 550 X 885 mm

 NO FROST			€
CB	+5 / -25 °C +10 / -5 °C	lam. plast.	7.140,00 €
CB	+5 / -25 °C +10 / -5 °C	acc. inox	8.370,00 €

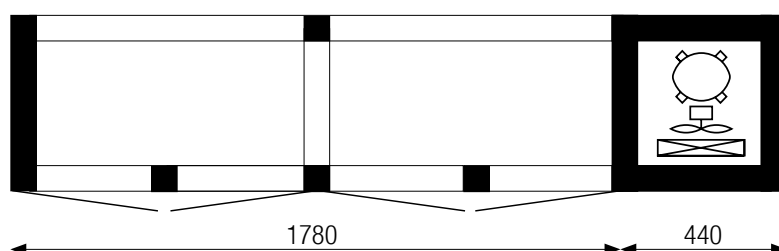



L E X S U S
L I N E

LEXSUS

LINEA LEXUS

LEXUS LINE

La linea LEXSUS è la versione TOP di gamma di tutte le vetrine verticali Tekna.

Con più di 100 modelli a listino la linea LEXSUS è la più completa presente sul mercato. Per la varietà di dimensioni, lati espositivi, temperatura di conservazione, tipo di refrigerazione, materiali, colori, accessori ed opzioni è in grado di soddisfare tutte le richieste che il mercato necessita. Dalle piccole esigenze a quelle più importanti è possibile trovare all'interno della linea il modello che può soddisfare qualsiasi richiesta.

Le vetrine presentano una SERIGRAFIA a scelta tra i colori GRIGIO e NERO, triplo vetro basso emissivo e doppia camera con gas inerte e resistenza anti condensa.

The LEXSUS line is the TOP of the range for all the upright Tekna showcases. With more than 100 models, the LEXSUS Line is the most complete on the market. For the variety of sizes, exhibition sides, storage temperature, type of refrigeration, materials, colours, options and accessories is able to meet all the demands of the market. It is possible within the line to find the model that can satisfy any request. For each model, you can have SILVER OR BLACK SILK-SCREEN PRINTING, triple-glazed low-emissivity and double room with inert gas and anti-condensation resistance glasses.

DI SERIE

DEFAULT

Finitura esterna: alluminio ossidato argento, bronzo o nero, cromato o satinato

Finitura interna: acciaio inox a specchio

Tubi luci LED - Termostato digitale touch posizionato in alto - Motore tropicalizzato

In tutti i modelli NT griglie refrigerate con ripiani vetro inclusi

External finish: anodized aluminium silver, bronze or black, chrome and satin

Inner finish: stainless steel mirror effect

LED lights tubes - Digital touch controller on top - Tropicalized version

In all NT models refrigerated grids with glass shelves included

OPTIONAL

OPTIONS

Vedere lista accessori

Per chi ne ha la necessità tutte le vetrine della serie LEXSUS possono essere realizzate con motore remoto fornito o meno (valvola di espansione a richiesta) o condensazione H2O.

Alcuni prodotti sono disponibili con R290.

L'ampia scelta di colori e materiali rende possibile l'integrazione armonica di una vetrina LEXSUS all'interno di ogni ambiente.

Check options list

The LEXSUS line showcases can be manufactured with remote engine supplied or not supplied by us (expansion valve on demand) or H2O condensation system.









Some products could be available with R290

The wide choice of colours and materials permits the harmonious integration of a LEXSUS showcase in any place.



760 X 760 X 1910 mm

R26-LX

 						
P	+2 / +10 °C	1	0,28	530	180 - 198	7.440,00 €
NFP	+10 / -5 °C	1	0,42	530	140 - 158	8.230,00 €
NFN	+5 / -25 °C	1	0,55	530	150 - 168	9.980,00 €

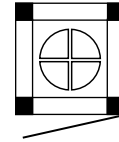

**3 LATI ESPOSITIVI
3 GLAZED SIDES**











SILVER



BRONZE

1500 X 760 X 1910 mm

R26/2-LX

 						
P	+2 / +10 °C	2	0,96	1260	315 - 345	11.880,00 €
NFP	+10 / -5 °C	2	1,20	1260	320 - 350	13.300,00 €
NFN	+5 / -25 °C	2	1,40	1260	330 - 360	16.410,00 €
CB	+5 / -25 °C +10 / -5 °C	2	1,00	1260	325 - 355	15.160,00 €

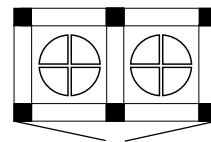

STANDARD

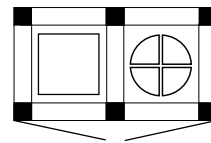

**SU RICHIESTA
ON REQUEST**

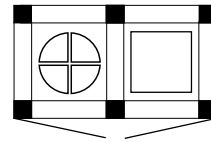

**SU RICHIESTA
ON REQUEST**

**3 LATI ESPOSITIVI
3 GLAZED SIDES**











SILVER



BRONZE

1500 X 760 X 1910 mm

R26/2 1M-LX

 						
P	+2 / +10 °C	2	0,80	1270	315 - 345	13.670,00 €
NFP	+10 / -5 °C	2	0,68	1270	320 - 350	15.340,00 €
NFN	+5 / -25 °C	2	1,20	1270	330 - 360	18.330,00 €

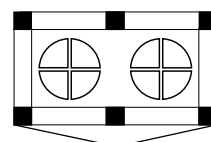

STANDARD

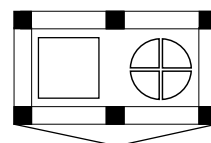

**SU RICHIESTA
ON REQUEST**

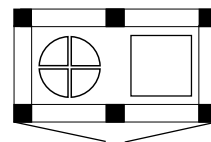

**SU RICHIESTA
ON REQUEST**

**3 LATI ESPOSITIVI
3 GLAZED SIDES**











SILVER



BRONZE

2100-LX

460 X 640 X 1910 mm

 						
P	+2 / +10 °C	1	0,16	250	75 - 85	3.160,00 €
NT	-15 / -25 °C	1	0,28	250	75 - 85	3.210,00 €
NFP	+10 / -5 °C	1	0,16	250	75 - 85	3.280,00 €
NFN	+5 / -25 °C	1	0,45	250	80 - 90	3.560,00 €

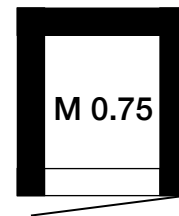

1 LATO ESPOSITIVO
1 GLAZED SIDE











SILVER



BRONZE

2200-LX

460 X 640 X 1910 mm

 						
P	+2 / +10 °C	1	0,16	250	75 - 85	3.300,00 €
NT	-15 / -25 °C	1	0,28	250	75 - 85	3.680,00 €
NFP	+10 / -5 °C	1	0,16	250	83 - 93	3.570,00 €
NFN	+5 / -25 °C	1	0,45	250	83 - 95	4.290,00 €

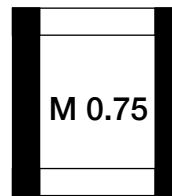

2 LATI ESPOSITIVI
2 GLAZED SIDES

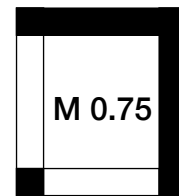



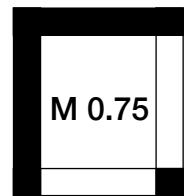





SILVER



BRONZE

2300-LX

460 X 640 X 1910 mm

 						
P	+2 / +10 °C	1	0,16	250	75 - 85	3.340,00 €
NT	-15 / -25 °C	1	0,28	250	75 - 85	3.680,00 €
NFP	+10 / -5 °C	1	0,20	250	90 - 100	3.650,00 €
NFN	+5 / -25 °C	1	0,60	250	95 - 105	4.660,00 €

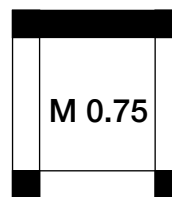

3 LATI ESPOSITIVI
3 GLAZED SIDES

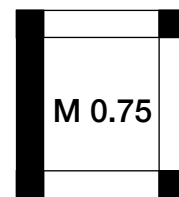



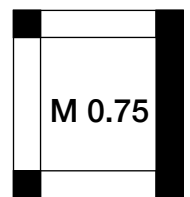





SILVER



BRONZE

2400-LX

460 X 640 X 1910 mm

 						
P	+2 / +10 °C	1	0,16	250	75 - 85	3.340,00 €
NT	-15 / -25 °C	1	0,28	250	75 - 85	4.540,00 €
NFP	+10 / -5 °C	1	0,20	250	100 - 110	3.760,00 €
NFN	+5 / -25 °C	1	0,60	250	105 - 115	4.930,00 €

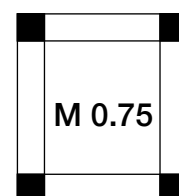







4 LATI ESPOSITIVI
4 GLAZED SIDES



SILVER



BRONZE

						
P	+2 / +10 °C	1	0,26	400	116 - 131	3.530,00 €
NT	-15 / -25 °C		0,40	400	117 - 132	3.660,00 €
NFP	+10 / -5 °C	1	0,40	380	120 - 132	3.920,00 €
NFN	+5 / -25 °C	1	0,50	380	122 - 137	4.560,00 €

4100-LX

670 X 640 X 1910 mm

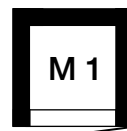







1 LATO ESPOSITIVO 1 GLAZED SIDE



SILVER



BRONZE

						
P	+2 / +10 °C	1	0,28	420	130 - 145	3.830,00 €
NT	-15 / -25 °C	1	0,55	420	127 - 142	4.510,00 €
NFP	+10 / -5 °C	1	0,42	400	130 - 145	4.290,00 €
NFN	+5 / -25 °C	1	0,65	400	133 - 148	5.580,00 €

4200-LX

670 X 640 X 1910 mm

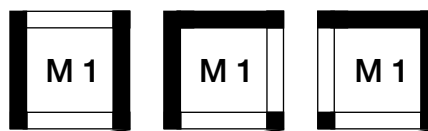







2 LATI ESPOSITIVI 2 SGLAZED SIDES



SILVER



BRONZE

						
P	+2 / +10 °C	1	0,40	430	140 - 155	3.990,00 €
NT	-15 / -25 °C	1	0,70	430	138 - 153	4.860,00 €
NFP	+10 / -5 °C	1	0,50	405	140 - 155	4.390,00 €
NFN	+5 / -25 °C	1	0,80	405	143 - 158	6.010,00 €

4300-LX

670 X 640 X 1910 mm

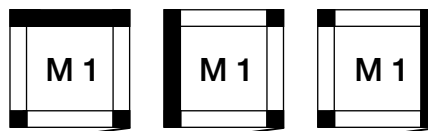







3 LATI ESPOSITIVI 3 GLAZED SIDES



SILVER



BRONZE

						
P	+2 / +10 °C	1	0,40	450	157 - 182	4.020,00 €
NT	-15 / -25 °C	1	0,75	450	155 - 180	4.960,00 €
PV	+2 / +10 °C	1	0,50	430	157 - 182	4.120,00 €
NFP	+10 / -5 °C	1	0,50	430	159 - 184	4.440,00 €
NFN	+5 / -25 °C	1	0,80	430	161 - 186	6.130,00 €

4400-LX

670 X 640 X 1910 mm

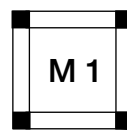







4 LATI ESPOSITIVI 4 GLAZED SIDES



SILVER



BRONZE

						
P	+2 / +10 °C	1	0,40	450	165 - 190	4.400,00 €
NT	-15 / -25 °C	1	0,50	430	165 - 190	4.570,00 €
NFP	+10 / -5 °C	1	0,50	430	167 - 192	4.990,00 €
NFN	+5 / -25 °C	1	0,85	430	169 - 195	6.680,00 €

4401-LX

670 X 640 X 1910 mm

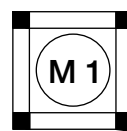

4 LATI ESPOSITIVI 4 GLAZED SIDES



SILVER



BRONZE

5100-LX

760 X 760 X 1910 mm

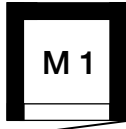

1 LATO ESPOSITIVO 1 GLAZED SIDE



P			+2 / +10 °C	1	0,28	530	138 - 156	4.560,00 €
NFP			+10 / -5 °C	1	0,42	510	140 - 158	5.440,00 €
NFN			+5 / -25 °C	1	0,55	510	150 - 168	5.900,00 €

5200-LX

760 X 760 X 1910 mm

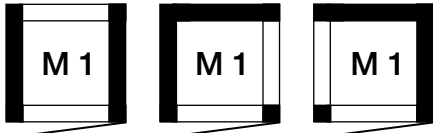

2 LATI ESPOSITIVI 2 GLAZED SIDES



P			+2 / +10 °C	1	0,28	540	150 - 168	4.950,00 €
NFP			+10 / -5 °C	1	0,50	530	160 - 178	5.900,00 €
NFN			+5 / -25 °C	1	0,68	530	164 - 182	6.730,00 €

5300-LX

760 X 760 X 1910 mm

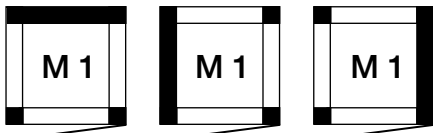

3 LATI ESPOSITIVI 3 GLAZED SIDES



P			+2 / +10 °C	1	0,45	550	160 - 178	5.100,00 €
NFP			+10 / -5 °C	1	0,50	530	170 - 188	5.930,00 €
NFN			+5 / -25 °C	1	0,68	530	175 - 193	7.270,00 €

5400-LX

760 X 760 X 1910 mm

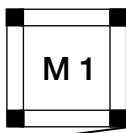

4 LATI ESPOSITIVI 4 GLAZED SIDES



P			+2 / +10 °C	1	0,45	560	170 - 188	4.920,00 €
NFP			+10 / -5 °C	1	0,50	540	180 - 198	5.630,00 €
NFN			+5 / -25 °C	1	0,70	540	185 - 203	7.340,00 €

5401-LX

760 X 760 X 1910 mm

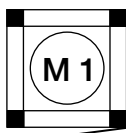







4 LATI ESPOSITIVI 4 GLAZED SIDES



P			+2 / +10 °C	1	0,50	560	180 - 198	5.720,00 €
NFP			+10 / -5 °C	1	0,55	540	190 - 208	6.520,00 €
NFN			+5 / -25 °C	1	0,75	540	195 - 213	8.210,00 €

900 X 640 X 1910 mm

9100-LX

							
P	+2 / +10 °C	1	0,28	555	138 - 156	4.510,00 €	
NT	-15 / -25 °C	1	0,45	555	140 - 158	5.110,00 €	
NFP	+10 / -5 °C	1	0,42	535	140 - 158	5.050,00 €	
NFN	+5 / -25 °C	1	0,55	535	142 - 160	5.820,00 €	



1 LATO ESPOSITIVO 1 GLAZED SIDE









SILVER



BRONZE

900 X 640 X 1910 mm

9200-LX

							
P	+2 / +10 °C	1	0,28	590	150 - 168	5.100,00 €	
NT	-15 / -25 °C	1	0,60	590	152 - 170	6.140,00 €	
NFP	+10 / -5 °C	1	0,50	570	152 - 170	5.750,00 €	
NFN	+5 / -25 °C	1	0,68	570	154 - 172	7.030,00 €	

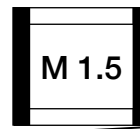

2 LATI ESPOSITIVI 2 GLAZED SIDES

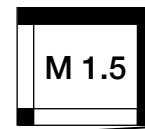
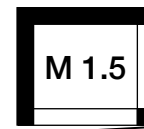







SILVER



BRONZE

900 X 640 X 1910 mm

9300-LX

							
P	+2 / +10 °C	1	0,40	430	140 - 155	5.160,00 €	
NT	-15 / -25 °C	1	0,70	430	138 - 153	6.670,00 €	
NFP	+10 / -5 °C	1	0,50	405	140 - 155	5.830,00 €	
NFN	+5 / -25 °C	1	0,80	405	143 - 158	7.660,00 €	

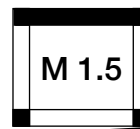

3 LATI ESPOSITIVI 3 GLAZED SIDES

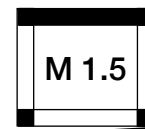
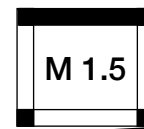







SILVER



BRONZE

900 X 640 X 1910 mm

9400-LX

							
P	+2 / +10 °C	1	0,45	620	153 - 170	5.290,00 €	
NT	-15 / -25 °C	1	0,70	620	155 - 173	6.890,00 €	
NFP	+10 / -5 °C	1	0,50	590	157 - 175	5.920,00 €	
NFN	+5 / -25 °C	1	0,68	590	159 - 177	7.860,00 €	

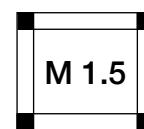

4 LATI ESPOSITIVI 4 GLAZED SIDES



SILVER



BRONZE

7100-LX

1320 X 640 X 1910 mm



1 LATO ESPOSITIVO 1 GLAZED SIDE



	STATIC NO FROST	TEMPERATURE	UNIT	KW	LT	KG	€
P		+2 / +10 °C	1	0,52	855	180 - 217	5.580,00 €
NT		-15 / -25 °C	1	1,00	855	185 - 222	5.990,00 €
NFP		+10 / -5 °C	1	0,50	810	192 - 229	6.510,00 €
NFN		+5 / -25 °C	1	1,00	810	202 - 239	7.010,00 €

7200-LX

1320 X 640 X 1910 mm



2 LATI ESPOSITIVI 2 GLAZED SIDES



	STATIC NO FROST	TEMPERATURE	UNIT	KW	LT	KG	€
P		+2 / +10 °C	1	0,56	905	203 - 240	6.020,00 €
NT		-15 / -25 °C	1	1,00	905	210 - 247	6.810,00 €
NFP		+10 / -5 °C	1	0,60	855	215 - 252	6.920,00 €
NFN		+5 / -25 °C	1	1,20	855	225 - 262	8.220,00 €

7300-LX

1320 X 640 X 1910 mm



3 LATI ESPOSITIVI 3 GLAZED SIDES



	STATIC NO FROST	TEMPERATURE	UNIT	KW	LT	KG	€
P		+2 / +10 °C	1	0,80	935	235 - 272	6.100,00 €
NT		-15 / -25 °C	1	1,20	935	245 - 282	7.340,00 €
NFP		+10 / -5 °C	1	0,68	880	238 - 275	7.010,00 €
NFN		+5 / -25 °C	1	1,20	880	248 - 285	9.080,00 €

7400-LX

1320 X 640 X 1910 mm



4 LATI ESPOSITIVI 4 GLAZED SIDES



	STATIC NO FROST	TEMPERATURE	UNIT	KW	LT	KG	€
P		+2 / +10 °C	1	0,80	935	235 - 272	6.140,00 €
NT		-15 / -25 °C	1	1,20	935	245 - 282	7.670,00 €
NFP		+10 / -5 °C	1	0,68	880	238 - 275	9.540,00 €
NFN		+5 / -25 °C	1	1,20	880	258 - 297	9.080,00 €

7401-LX

1320 X 640 X 1910 mm

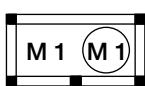







4 LATI ESPOSITIVI 4 GLAZED SIDES



	STATIC NO FROST	TEMPERATURE	UNIT	KW	LT	KG	€
P		+2 / +10 °C	1	0,80	935	256 - 291	6.490,00 €
NFP		+10 / -5 °C	1	0,68	880	248 - 287	7.550,00 €
NFN		+5 / -25 °C	1	1,20	880	268 - 305	10.560,00 €

7100 XL-LX

							
P	+2 / +10 °C	1	0,52	1052	180 - 217	6.800,00 €	
NFP	+10 / -5 °C	1	0,50	1007	192 - 229	7.660,00 €	
NFN	+5 / -25 °C	1	1,00	1007	202 - 239	8.320,00 €	



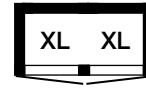



1320 X 760 X 1910 mm



1 LATO ESPOSITIVO 1 GLAZED SIDE



7200 XL-LX

							
P	+2 / +10 °C	1	0,56	1102	203 - 240	7.360,00 €	
NFP	+10 / -5 °C	1	0,60	1052	215 - 252	8.430,00 €	
NFN	+5 / -25 °C	1	1,20	1052	225 - 262	10.060,00 €	







1320 X 760 X 1910 mm



2 LATI ESPOSITIVI 2 GLAZED SIDES



7300 XL-LX

							
P	+2 / +10 °C	1	0,80	1132	235 - 272	7.480,00 €	
NFP	+10 / -5 °C	1	0,68	1077	238 - 275	8.570,00 €	
NFN	+5 / -25 °C	1	1,20	1077	248 - 285	11.100,00 €	

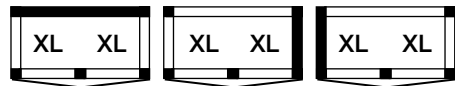

1320 X 760 X 1910 mm



3 LATI ESPOSITIVI 3 GLAZED SIDES



7400 XL-LX

							
P	+2 / +10 °C	1	0,80	1132	35 - 272	7.520,00 €	
NFP	+10 / -5 °C	1	0,68	1077	238 - 275	8.670,00 €	
NFN	+5 / -25 °C	1	1,20	1077	258 - 297	11.100,00 €	



1320 X 760 X 1910 mm



4 LATI ESPOSITIVI 4 GLAZED SIDES



7401 XL-LX

							
P	+2 / +10 °C	1	0,80	1132	256 - 291	7.940,00 €	
NFP	+10 / -5 °C	1	0,68	1077	248 - 287	9.240,00 €	
NFN	+5 / -25 °C	1	1,20	1077	268 - 305	12.920,00 €	

1320 X 760 X 1910 mm

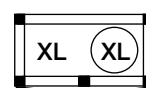

4 LATI ESPOSITIVI 4 GLAZED SIDES



8100-LX

1320 X 640 X 1910 mm

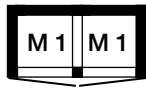

1 LATO ESPOSITIVO 1 GLAZED SIDE



P		+2 / +10 °C	2	0,52	855	210 - 247	6.300,00 €
NT		-15 / -25 °C	2	0,80	855	220 - 257	6.790,00 €
NP		-15 / -25 °C +2 / +10 °C	2	0,60	855	215 - 252	6.710,00 €
NFP		+10 / -5 °C	2	0,80	810	222 - 259	7.120,00 €
NFN		+5 / -25 °C	2	1,00	810	232 - 269	8.120,00 €
CB		+5 / -25 °C +10 / -5 °C	2	0,90	810	227 - 264	7.620,00 €

8200-LX

1320 X 640 X 1910 mm



2 LATI ESPOSITIVI 2 GLAZED SIDES



P		+2 / +10 °C	2	0,56	905	233 - 270	6.700,00 €
NT		-15 / -25 °C	2	1,10	905	243 - 280	7.860,00 €
NP		-15 / -25 °C +2 / +10 °C	2	0,80	905	238 - 275	7.200,00 €
NFP		+10 / -5 °C	2	0,84	855	245 - 282	7.740,00 €
NFN		+5 / -25 °C	2	1,30	855	255 - 292	9.710,00 €
CB		+5 / -25 °C +10 / -5 °C	2	1,07	855	250 - 287	8.670,00 €

8300-LX

1320 X 640 X 1910 mm

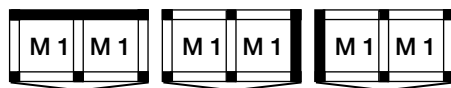

3 LATI ESPOSITIVI 3 GLAZED SIDES



P		+2 / +10 °C	2	0,80	915	255 - 292	6.930,00 €
NT		-15 / -25 °C	2	1,50	915	265 - 302	8.240,00 €
NP		-15 / -25 °C +2 / +10 °C	2	1,10	915	260 - 297	7.860,00 €
NFP		+10 / -5 °C	2	1,00	875	258 - 295	8.030,00 €
NFN		+5 / -25 °C	2	1,36	875	268 - 305	10.780,00 €
CB		+5 / -25 °C +10 / -5 °C	2	1,18	875	263 - 300	9.370,00 €

8400-LX

1320 X 640 X 1910 mm

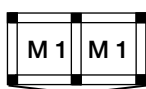

4 LATI ESPOSITIVI 4 GLAZED SIDES



P		+2 / +10 °C	2	0,80	935	278 - 315	6.950,00 €
NT		-15 / -25 °C	2	1,50	935	288 - 315	8.370,00 €
NP		-15 / -25 °C +2 / +10 °C	2	1,10	935	283 - 320	8.070,00 €
NFP		+10 / -5 °C	2	1,00	880	262 - 299	8.150,00 €
NFN		+5 / -25 °C	2	1,36	880	272 - 309	11.000,00 €
CB		+5 / -25 °C +10 / -5 °C	2	1,18	880	267 - 304	9.560,00 €

8401-LX



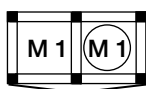



1320 X 640 X 1910 mm



4 LATI ESPOSITIVI 4 GLAZED SIDES



P		+2 / +10 °C	2	0,80	935	284 - 321	8.050,00 €
NP		-15 / -25 °C +2 / +10 °C	2	1,10	935	298 - 335	8.580,00 €
NFP		+10 / -5 °C	2	1,00	880	278 - 315	8.450,00 €
NFN		+5 / -25 °C	2	1,36	880	288 - 325	12.390,00 €
CB		+5 / -25 °C +10 / -5 °C	2	1,18	880	283 - 320	10.540,00 €

						
P	+2 / +10 °C	2	0,55	1110	250 - 280	8.000,00 €
NFP	+10 / -5 °C	2	0,84	1065	252 - 282	9.570,00 €
NFN	+5 / -25 °C	2	1,10	1065	256 - 286	10.380,00 €
CB	+5 / -25 °C +10 / -5 °C	2	0,97	1065	254 - 284	10.210,00 €





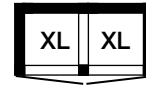

10100-LX

1500 X 760 X 1910 mm



1 LATO ESPOSITIVO 1 GLAZED SIDE



						
P	+2 / +10 °C	2	0,56	1180	275 - 305	8.710,00 €
NFP	+10 / -5 °C	2	1,00	1135	280 - 310	10.380,00 €
NFN	+5 / -25 °C	2	1,36	1135	290 - 320	12.410,00 €
CB	+5 / -25 °C +10 / -5 °C	2	1,18	1135	285 - 315	11.110,00 €





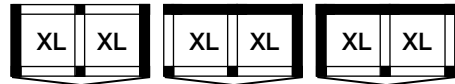

10200-LX

1500 X 760 X 1910 mm



2 LATI ESPOSITIVI 2 GLAZED SIDES



						
P	+2 / +10 °C	2	0,90	1200	280 - 310	9.280,00 €
NFP	+10 / -5 °C	2	1,00	1150	290 - 320	10.550,00 €
NFN	+5 / -25 °C	2	1,36	1150	300 - 330	13.470,00 €
CB	+5 / -25 °C +10 / -5 °C	2	1,18	1150	295 - 325	11.700,00 €





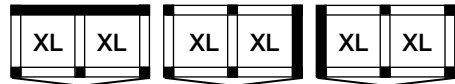

10300-LX

1500 X 760 X 1910 mm



3 LATI ESPOSITIVI 3 GLAZED SIDES



						
P	+2 / +10 °C	1	0,90	1210	305 - 335	9.410,00 €
NFP	+10 / -5 °C	1	1,00	1160	310 - 340	10.700,00 €
NFN	+5 / -25 °C	1	1,40	1160	320 - 350	13.940,00 €
CB	+5 / -25 °C +10 / -5 °C	1	1,20	1160	315 - 345	12.690,00 €





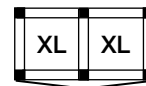

10400-LX

1500 X 760 X 1910 mm



4 LATI ESPOSITIVI 4 GLAZED SIDES



						
P	+2 / +10 °C	2	0,90	1260	315 - 345	10.250,00 €
NFP	+10 / -5 °C	2	1,00	1160	320 - 350	11.660,00 €
NFN	+5 / -25 °C	2	1,40	1160	330 - 360	14.740,00 €
CB	+5 / -25 °C	2	1,20	1160	325 - 355	13.520,00 €

10401-LX

1500 X 760 X 1910 mm

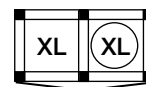

4 LATI ESPOSITIVI 4 GLAZED SIDES



1310-LX

1550 X 640 X 1910 mm

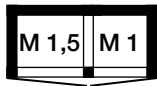

1 LATO ESPOSITIVO 1 GLAZED SIDE



P	+2 / +10 °C	2	0,50	1000	252 - 294	7.970,00 €	
NT	-15 / -25 °C	2	0,90	1000	262 - 304	8.720,00 €	
NP	-15 / -25 °C +2 / +10 °C	2	0,70	1000	257 - 299	8.940,00 €	
NFP	+10 / -5 °C	2	0,90	1000	264 - 306	9.200,00 €	
NFN	+5 / -25 °C	2	1,50	1000	274 - 316	10.470,00 €	
CB	+5 / -25 °C +10 / -5 °C	2	1,20	1000	269 - 311	9.840,00 €	

1320-LX

1550 X 640 X 1910 mm

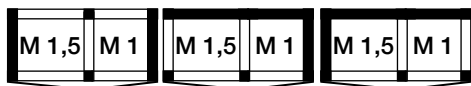

2 LATI ESPOSITIVI 2 GLAZED SIDES



P	+2 / +10 °C	2	0,50	1070	275 - 317	8.630,00 €	
NT	-15 / -25 °C	2	0,90	1070	285 - 327	10.550,00 €	
NP	-15 / -25 °C +2 / +10 °C	2	0,70	1070	287 - 322	9.440,00 €	
NFP	+10 / -5 °C	2	0,90	1070	277 - 319	9.960,00 €	
NFN	+5 / -25 °C	2	1,50	1070	287 - 329	12.510,00 €	
CB	+5 / -25 °C +10 / -5 °C	2	1,20	1070	282 - 324	11.220,00 €	

1330-LX

1550 X 640 X 1910 mm

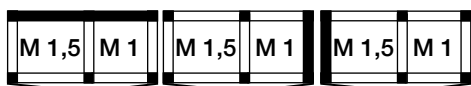

3 LATI ESPOSITIVI 3 GLAZED SIDES



P	+2 / +10 °C	2	0,90	1080	290 - 332	8.890,00 €	
NT	-15 / -25 °C	2	1,50	1080	300 - 342	11.350,00 €	
NP	-15 / -25 °C +2 / +10 °C	2	1,20	1080	295 - 337	9.950,00 €	
NFP	+10 / -5 °C	2	0,90	1080	298 - 340	10.510,00 €	
NFN	+5 / -25 °C	2	1,50	1080	308 - 350	13.460,00 €	
CB	+5 / -25 °C +10 / -5 °C	2	1,20	1080	303 - 345	11.710,00 €	

1340-LX

1550 X 640 X 1910 mm

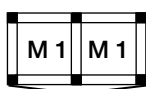

4 LATI ESPOSITIVI 4 GLAZED SIDES



P	+2 / +10 °C	2	0,90	1090	319 - 361	9.130,00 €	
NT	-15 / -25 °C	2	1,50	1090	329 - 371	11.730,00 €	
NP	-15 / -25 °C +2 / +10 °C	2	1,20	1090	324 - 366	10.170,00 €	
NFP	+10 / -5 °C	2	0,90	1090	319 - 362	10.680,00 €	
NFN	+5 / -25 °C	2	1,50	1090	329 - 372	14.160,00 €	
CB	+5 / -25 °C +10 / -5 °C	2	1,20	1090	324 - 367	12.110,00 €	

1341-LX



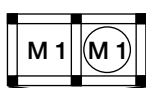



1550 X 640 X 1910 mm



4 LATI ESPOSITIVI 4 GLAZED SIDES



P	+2 / +10 °C	2	0,90	1090	327 - 369	10.480,00 €	
NP	-15 / -25 °C +2 / +10 °C	2	1,20	1090	332 - 374	11.540,00 €	
NFP	+10 / -5 °C	2	0,90	1090	327 - 369	11.580,00 €	
NFN	+5 / -25 °C	2	1,50	1090	337 - 380	16.260,00 €	
CB	+5 / -25 °C +10 / -5 °C	2	1,20	1090	332 - 374	13.920,00 €	

						
P	+2 / +10 °C	2	0,55	1160	253 - 295	8.120,00 €
NT	-15 / -25 °C	2	1,00	1160	263 - 305	9.090,00 €
NP	-15 / -25 °C +2 / +10 °C	2	0,80	1160	258 - 300	8.770,00 €
NFP	+10 / -5 °C	2	0,84	1115	255 - 297	8.860,00 €
NFN	+5 / -25 °C	2	1,10	1115	259 - 301	10.100,00 €
CB	+5 / -25 °C +10 / -5 °C	2	0,97	1115	257 - 299	9.500,00 €





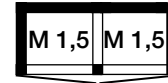

1810-LX

1780 X 640 X 1910 mm



1 LATO ESPOSITIVO 1 SIDE GLASS



						
P	+2 / +10 °C	2	0,56	1230	275 - 317	8.370,00 €
NT	-15 / -25 °C	2	1,20	1230	285 - 327	10.590,00 €
NP	-15 / -25 °C +2 / +10 °C	2	0,85	1230	280 - 322	9.460,00 €
NFP	+10 / -5 °C	2	1,00	1185	273 - 315	9.620,00 €
NFN	+5 / -25 °C	2	1,36	1185	283 - 325	12.090,00 €
CB	+5 / -25 °C +10 / -5 °C	2	1,18	1185	278 - 319	10.830,00 €





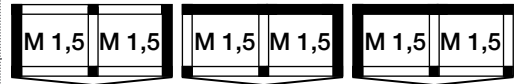

1820-LX

1780 X 640 X 1910 mm



2 LATI ESPOSITIVI 2 GLAZED SIDES



						
P	+2 / +10 °C	2	0,90	1250	280 - 323	8.660,00 €
NT	-15 / -25 °C	2	1,40	1250	290 - 333	11.400,00 €
NP	-15 / -25 °C +2 / +10 °C	2	1,10	1250	285 - 328	9.990,00 €
NFP	+10 / -5 °C	2	1,00	1200	290 - 332	9.680,00 €
NFN	+5 / -25 °C	2	1,36	1200	300 - 342	13.010,00 €
CB	+5 / -25 °C +10 / -5 °C	2	1,18	1200	295 - 337	11.300,00 €





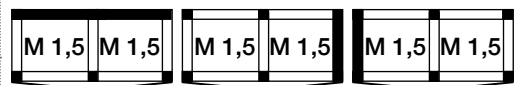

1830-LX

1780 X 640 X 1910 mm



3 LATI ESPOSITIVI 3 GLAZED SIDES



						
P	+2 / +10 °C	2	0,90	1260	305 - 348	9.680,00 €
NT	-15 / -25 °C	2	1,50	1260	315 - 358	13.010,00 €
NP	-15 / -25 °C +2 / +10 °C	2	1,20	1260	310 - 353	11.300,00 €
NFP	+10 / -5 °C	2	1,00	1210	310 - 352	9.840,00 €
NFN	+5 / -25 °C	2	1,40	1210	320 - 362	13.320,00 €
CB	+5 / -25 °C +10 / -5 °C	2	1,20	1210	315 - 357	11.550,00 €

1840-LX

1780 X 640 X 1910 mm

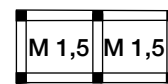

4 LATI ESPOSITIVI 4 GLAZED SIDES



1210-LX

1970 X 640 X 1910 mm

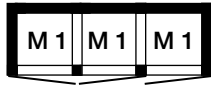

1 LATO ESPOSITIVO 1 GLAZED SIDE



P		+2 / +10 °C	2	0,80	1200	320 - 360	8.930,00 €
NT		-15 / -25 °C	2	1,20	1200	320 - 360	9.930,00 €
NP		-15 / -25 °C +2 / +10 °C	2	1,00	1200	320 - 360	9.880,00 €
NFP		+10 / -5 °C	2	1,20	1200	315 - 355	10.780,00 €
NFN		+5 / -25 °C	2	1,50	1200	325 - 365	11.700,00 €
CB		+5 / -25 °C +10 / -5 °C	2	1,35	1200	320 - 360	10.970,00 €

1220-LX

1970 X 640 X 1910 mm

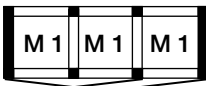

2 LATI ESPOSITIVI
2 GLAZED SIDES

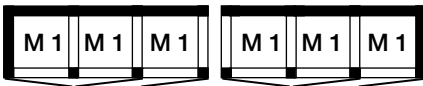

P		+2 / +10 °C	2	0,90	1260	350 - 390	9.340,00 €
NT		-15 / -25 °C	2	1,65	1260	345 - 385	11.620,00 €
NP		-15 / -25 °C +2 / +10 °C	2	1,38	1260	350 - 390	10.640,00 €
NFP		+10 / -5 °C	2	1,26	1220	340 - 380	11.480,00 €
NFN		+5 / -25 °C	2	1,95	1220	350 - 390	13.720,00 €
CB		+5 / -25 °C +10 / -5 °C	2	1,60	1220	345 - 385	12.280,00 €

1230-LX

1970 X 640 X 1910 mm



3 LATI ESPOSITIVI
3 GLAZED SIDES

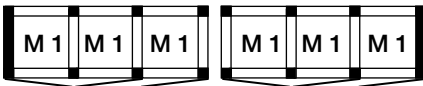

P		+2 / +10 °C	2	1,20	1290	355 - 395	9.390,00 €
NT		-15 / -25 °C	2	2,10	1290	365 - 405	11.960,00 €
NP		-15 / -25 °C +2 / +10 °C	2	1,80	1290	360 - 400	10.710,00 €
NFP		+10 / -5 °C	2	1,50	1230	360 - 400	11.570,00 €
NFN		+5 / -25 °C	2	2,04	1230	370 - 410	14.800,00 €
CB		+5 / -25 °C +10 / -5 °C	2	1,75	1230	365 - 405	12.840,00 €

1240-LX

1970 X 640 X 1910 mm

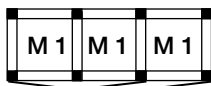

4 LATI ESPOSITIVI 4 GLAZED SIDES



P		+2 / +10 °C	2	1,20	1350	385 - 425	9.440,00 €
NT		-15 / -25 °C	2	2,25	1350	385 - 425	12.120,00 €
NP		-15 / -25 °C +2 / +10 °C	2	1,90	1350	390 - 430	10.930,00 €
NFP		+10 / -5 °C	2	1,50	1240	380 - 420	11.990,00 €
NFN		+5 / -25 °C	2	2,04	1240	390 - 430	15.120,00 €
CB		+5 / -25 °C +10 / -5 °C	2	1,75	1240	385 - 425	13.290,00 €

1241-LX

1970 X 640 X 1910 mm

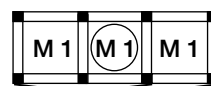

4 LATI ESPOSITIVI 4 GLAZED SIDES



P		+2 / +10 °C	2	1,20	1350	393 - 433	11.540,00 €
NP		-15 / -25 °C +2 / +10 °C	2	1,90	1350	398 - 438	12.560,00 €
NFP		+10 / -5 °C	2	1,50	1240	388 - 428	12.740,00 €
NFN		+5 / -25 °C	2	2,04	1240	398 - 438	17.440,00 €
CB		+5 / -25 °C +10 / -5 °C	2	1,75	1240	393 - 433	15.090,00 €

STATIC NO FROST	TEMPERATURE	NO. OF DOORS	KW	LT	KG	€
P	+2 / +10 °C	1	1,00	1350	380 - 420	6.710,00 €
NFP	+10 / -5 °C	1	1,00	1310	388 - 428	8.010,00 €
NFN	+5 / -25 °C	2	1,20	1310	398 - 438	9.970,00 €

1510-LX

1970 X 640 X 1910 mm



1 LATO ESPOSITIVO 1 GLAZED SIDE



STATIC NO FROST	TEMPERATURE	NO. OF DOORS	KW	LT	KG	€
P	+2 / +10 °C	1	1,00	1350	382 - 422	7.090,00 €
NFP	+10 / -5 °C	1	1,00	1310	390 - 430	8.490,00 €
NFN	+5 / -25 °C	2	2,50	1310	400 - 440	13.310,00 €

1535-LX

1970 X 640 X 1910 mm



3 LATI ESPOSITIVI 3 GLAZED SIDES



STATIC NO FROST	TEMPERATURE	NO. OF DOORS	KW	LT	KG	€
P	+2 / +10 °C	1	1,20	1350	390 - 430	7.960,00 €
NFP	+10 / -5 °C	1	1,20	1310	395 - 435	8.910,00 €
NFN	+5 / -25 °C	2	2,50	1310	400 - 440	14.020,00 €

1540-LX

1970 X 640 X 1910 mm



4 LATI ESPOSITIVI 4 GLAZED SIDES



STATIC NO FROST	TEMPERATURE	NO. OF DOORS	KW	LT	KG	€
P	+2 / +10 °C	2	1,20	1350	390 - 430	9.100,00 €
NP	-15 / -25 °C +2 / +10 °C	2	1,40	1350	390 - 430	10.800,00 €
NFP	+10 / -5 °C	2	1,20	1310	395 - 435	10.040,00 €
CB	+5 / -25 °C +10 / -5 °C	2	1,40	1310	400 - 440	11.010,00 €

1541-LX

1970 X 640 X 1910 mm

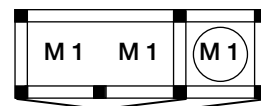

4 LATI ESPOSITIVI 4 GLAZED SIDES



STATIC NO FROST	TEMPERATURE	NO. OF DOORS	KW	LT	KG	€
P	+2 / +10 °C	2	1,20	1350	382 - 422	8.370,00 €
NT	-15 / -25 °C	2	1,40	1350	382 - 422	11.520,00 €
NP	-15 / -25 °C +2 / +10 °C	2	1,60	1350	390 - 430	9.210,00 €
NFP	+10 / -5 °C	2	1,20	1310	390 - 430	9.670,00 €
CB	+5 / -25 °C +10 / -5 °C	2	1,40	1310	400 - 440	10.630,00 €

1544-LX

1970 X 640 X 1910 mm

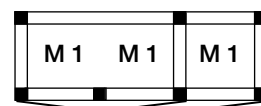

4 LATI ESPOSITIVI 4 GLAZED SIDES



1410-LX

2200 X 640 X 1910 mm

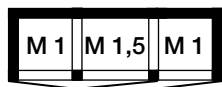

1 LATO ESPOSITIVO 1 GLAZED SIDE



P			+2 / +10 °C	3	0,80	1355	335 - 375	11.930,00 €
NT			-15 / -25 °C	3	1,25	1355	330 - 370	12.630,00 €
NP			-15 / -25 °C +2 / +10 °C	3	1,08	1355	335 - 375	12.340,00 €
NFP			+10 / -5 °C	3	1,20	1330	325 - 365	13.660,00 €
NFN			+5 / -25 °C	3	1,55	1330	335 - 375	14.800,00 €
CB			+5 / -25 °C +10 / -5 °C	3	1,35	1330	330 - 370	14.610,00 €

1420-LX

2200 X 640 X 1910 mm



2 LATI ESPOSITIVI
2 GLAZED SIDES



P			+2 / +10 °C	3	0,90	1430	360 - 400	12.110,00 €
NT			-15 / -25 °C	3	1,70	1430	355 - 395	15.070,00 €
NP			-15 / -25 °C +2 / +10 °C	3	1,38	1430	360 - 400	13.370,00 €
NFP			+10 / -5 °C	3	1,30	1370	350 - 390	14.790,00 €
NFN			+5 / -25 °C	3	2,00	1370	360 - 400	17.760,00 €
CB			+5 / -25 °C +10 / -5 °C	3	1,60	1370	355 - 395	15.860,00 €

1430-LX

2200 X 640 X 1910 mm



3 LATI ESPOSITIVI
3 GLAZED SIDES



P			+2 / +10 °C	3	1,25	1480	380 - 420	12.130,00 €
NT			-15 / -25 °C	3	2,10	1480	375 - 415	16.250,00 €
NP			-15 / -25 °C +2 / +10 °C	3	1,85	1480	380 - 420	14.180,00 €
NFP			+10 / -5 °C	3	1,55	1400	370 - 410	14.890,00 €
NFN			+5 / -25 °C	3	2,10	1400	380 - 420	19.110,00 €
CB			+5 / -25 °C +10 / -5 °C	3	1,80	1400	375 - 415	16.580,00 €

1440-LX

2200 X 640 X 1910 mm

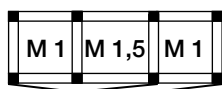

4 LATI ESPOSITIVI 4 GLAZED SIDES



P			+2 / +10 °C	3	1,25	1530	400 - 440	11.940,00 €
NT			-15 / -25 °C	3	2,25	1530	395 - 435	16.880,00 €
NP			-15 / -25 °C +2 / +10 °C	3	1,95	1530	400 - 440	14.610,00 €
NFP			+10 / -5 °C	3	1,55	1455	390 - 430	15.110,00 €
NFN			+5 / -25 °C	3	2,10	1455	400 - 440	19.870,00 €
CB			+5 / -25 °C +10 / -5 °C	3	1,80	1455	395 - 435	17.120,00 €

1740-LX

2200 X 640 X 1910 mm

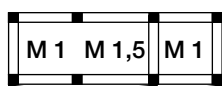

4 LATI ESPOSITIVI 4 GLAZED SIDES



P			+2 / +10 °C	2	1,25	1530	390 - 430	10.970,00 €
NP			-15 / -25 °C +2 / +10 °C	2	1,95	1530	390 - 430	12.060,00 €
NFP			+10 / -5 °C	2	1,55	1455	380 - 420	12.480,00 €
CB			+5 / -25 °C +10 / -5 °C	2	1,80	1455	385 - 425	13.800,00 €

STATIC NO FROST	TEMPERATURE	GLAZING	KW	LT	KG	€
P	+2 / +10 °C	3	0,90	1510	340 - 380	12.490,00 €
NT	-15 / -25 °C	3	1,30	1510	350 - 390	15.970,00 €
NP	-15 / -25 °C +2 / +10 °C	3	1,08	1510	345 - 385	13.500,00 €
NFP	+10 / -5 °C	3	1,25	1510	340 - 380	14.950,00 €
NFN	+5 / -25 °C	3	1,60	1510	355 - 395	18.850,00 €
CB	+5 / -25 °C +10 / -5 °C	3	1,35	1510	345 - 385	16.850,00 €

1610-LX

2430 X 640 X 1910 mm

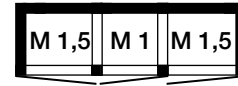

1 LATO ESPOSITIVO 1 GLAZED SIDE



STATIC NO FROST	TEMPERATURE	GLAZING	KW	LT	KG	€
P	+2 / +10 °C	3	0,88	1600	365 - 405	12.040,00 €
NT	-15 / -25 °C	3	1,70	1600	375 - 415	13.370,00 €
NP	-15 / -25 °C +2 / +10 °C	3	1,38	1600	370 - 410	13.030,00 €
NFP	+10 / -5 °C	3	1,35	1540	370 - 410	13.750,00 €
NFN	+5 / -25 °C	3	2,10	1540	380 - 420	15.730,00 €
CB	+5 / -25 °C +10 / -5 °C	3	1,60	1540	375 - 415	14.750,00 €

1620-LX

2430 X 640 X 1910 mm

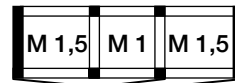

2 LATI ESPOSITIVI
2 GLAZED SIDES

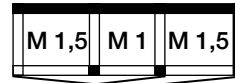

STATIC NO FROST	TEMPERATURE	GLAZING	KW	LT	KG	€
P	+2 / +10 °C	3	1,30	1670	385 - 425	12.860,00 €
NT	-15 / -25 °C	3	2,10	1670	395 - 435	17.190,00 €
NP	-15 / -25 °C +2 / +10 °C	3	1,85	1670	390 - 430	14.280,00 €
NFP	+10 / -5 °C	3	1,60	1585	390 - 430	15.040,00 €
NFN	+5 / -25 °C	3	2,15	1585	400 - 440	20.280,00 €
CB	+5 / -25 °C +10 / -5 °C	3	1,80	1585	395 - 435	17.590,00 €

1630-LX

2430 X 640 X 1910 mm



3 LATI ESPOSITIVI
3 GLAZED SIDES

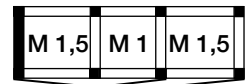
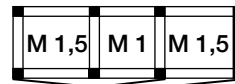

STATIC NO FROST	TEMPERATURE	GLAZING	KW	LT	KG	€
P	+2 / +10 °C	3	1,30	1710	405 - 445	13.110,00 €
NT	-15 / -25 °C	3	2,25	1710	415 - 455	17.910,00 €
NP	-15 / -25 °C +2 / +10 °C	3	1,95	1710	410 - 450	15.500,00 €
NFP	+10 / -5 °C	3	1,60	1620	410 - 450	15.260,00 €
NFN	+5 / -25 °C	3	2,15	1620	420 - 460	21.060,00 €
CB	+5 / -25 °C +10 / -5 °C	3	1,80	1620	415 - 455	17.700,00 €

1640-LX

2430 X 640 X 1910 mm

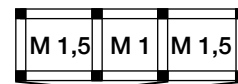

4 LATI ESPOSITIVI 4 GLAZED SIDES



STATIC NO FROST	TEMPERATURE	GLAZING	KW	LT	KG	€
P	+2 / +10 °C	3	1,30	1710	413 - 453	14.000,00 €
NP	-15 / -25 °C +2 / +10 °C	3	1,95	1710	418 - 458	16.490,00 €
NFP	+10 / -5 °C	3	1,60	1620	418 - 458	16.630,00 €
NFN	+5 / -25 °C	3	2,15	1620	428 - 468	22.250,00 €
CB	+5 / -25 °C +10 / -5 °C	3	1,80	1620	423 - 463	19.660,00 €

1641-LX

2430 X 640 X 1910 mm

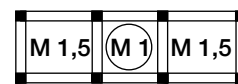

4 LATI ESPOSITIVI 4 SGLAZED SIDES



2010-LX

2660 X 640 X 1910 mm

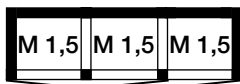

1 LATO ESPOSITIVO 1 GLAZED SIDE



							€
P	+2 / +10 °C	3	0,90	1665	360 - 400	11.360,00 €	
NT	-15 / -25 °C	3	1,35	1665	370 - 410	13.230,00 €	
NP	-15 / -25 °C +2 / +10 °C	3	1,18	1665	365 - 405	12.280,00 €	
NFP	+10 / -5 °C	3	1,30	1605	365 - 405	13.630,00 €	
NFN	+5 / -25 °C	3	1,65	1605	375 - 415	15.600,00 €	
CB	+5 / -25 °C +10 / -5 °C	3	1,40	1605	370 - 410	14.600,00 €	

2020-LX

2660 X 640 X 1910 mm



2 LATI ESPOSITIVI
2 GLAZED SIDES

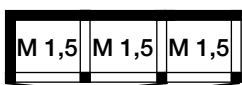
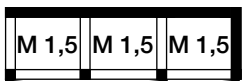

							€
P	+2 / +10 °C	3	0,90	1770	385 - 425	12.320,00 €	
NT	-15 / -25 °C	3	1,80	1770	395 - 435	15.810,00 €	
NP	-15 / -25 °C +2 / +10 °C	3	1,48	1770	390 - 430	14.010,00 €	
NFP	+10 / -5 °C	3	1,40	1710	390 - 430	14.800,00 €	
NFN	+5 / -25 °C	3	2,15	1710	400 - 440	18.630,00 €	
CB	+5 / -25 °C +10 / -5 °C	3	1,65	1710	395 - 435	16.650,00 €	

2030-LX

2660 X 640 X 1910 mm



3 LATI ESPOSITIVI
3 GLAZED SIDES



							€
P	+2 / +10 °C	3	1,35	1860	405 - 445	12.740,00 €	
NT	-15 / -25 °C	3	2,10	1860	415 - 455	17.040,00 €	
NP	-15 / -25 °C +2 / +10 °C	3	1,85	1860	410 - 450	14.810,00 €	
NFP	+10 / -5 °C	3	1,65	1770	410 - 450	14.490,00 €	
NFN	+5 / -25 °C	3	2,20	1770	420 - 460	20.070,00 €	
CB	+5 / -25 °C +10 / -5 °C	3	1,85	1770	415 - 455	17.420,00 €	

2040-LX

2660 X 640 X 1910 mm

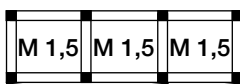

4 LATI ESPOSITIVI 4 GLAZED SIDES



							€
P	+2 / +10 °C	3	1,35	1890	425 - 465	12.970,00 €	
NT	-15 / -25 °C	3	2,25	1890	435 - 475	17.740,00 €	
NP	-15 / -25 °C +2 / +10 °C	3	1,95	1890	430 - 470	15.350,00 €	
NFP	+10 / -5 °C	3	1,55	1785	430 - 470	15.110,00 €	
NFN	+5 / -25 °C	3	2,20	1785	440 - 480	20.830,00 €	
CB	+5 / -25 °C +10 / -5 °C	3	1,85	1785	435 - 475	17.970,00 €	

M 0,75

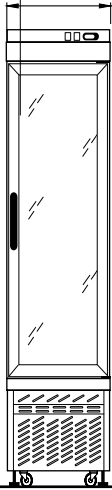

M 1

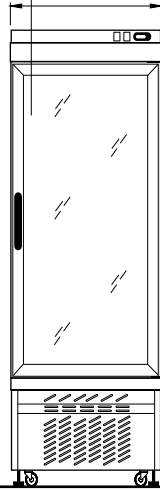

M 1,5

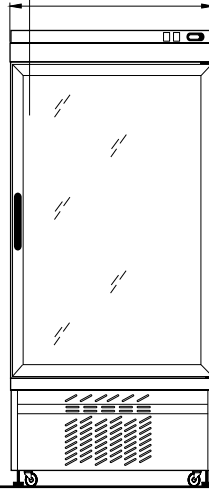

M 2

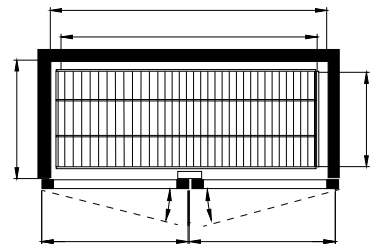
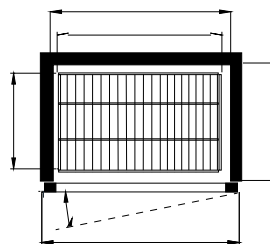
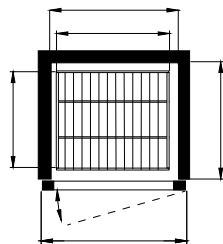
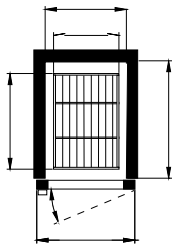
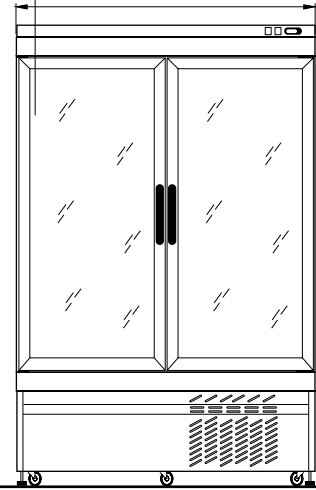

M 2,5

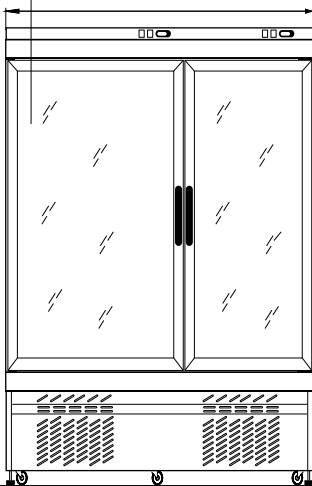

M 3

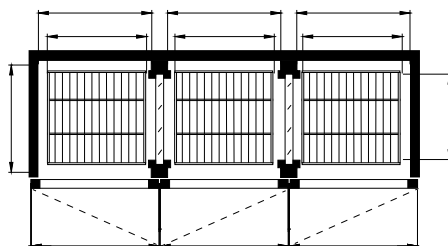
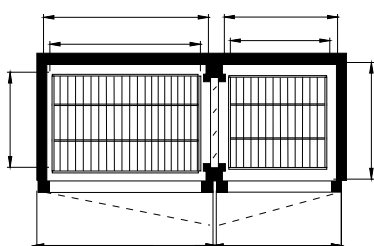
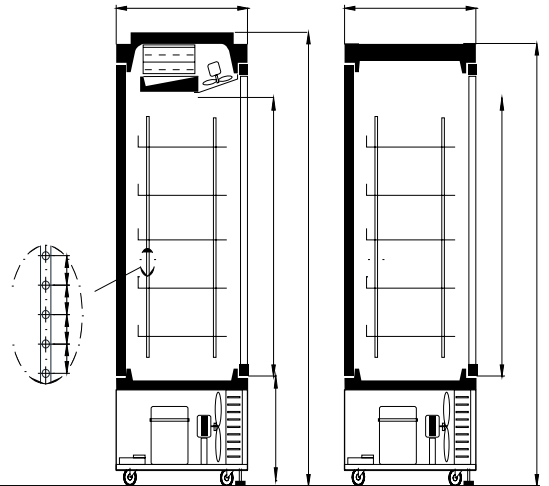

M 3

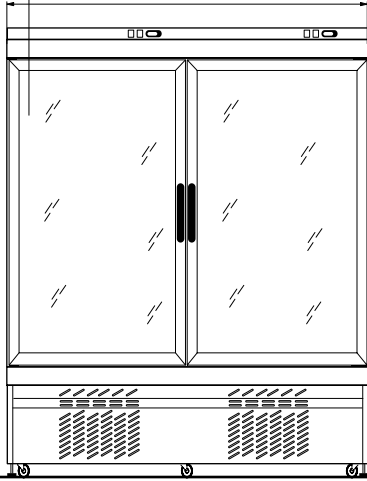

M 4,5

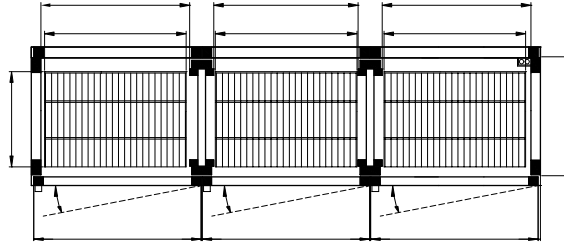
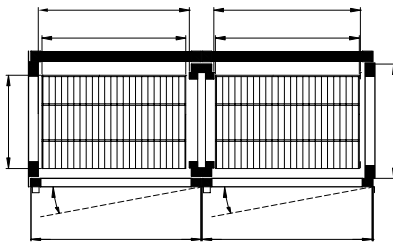
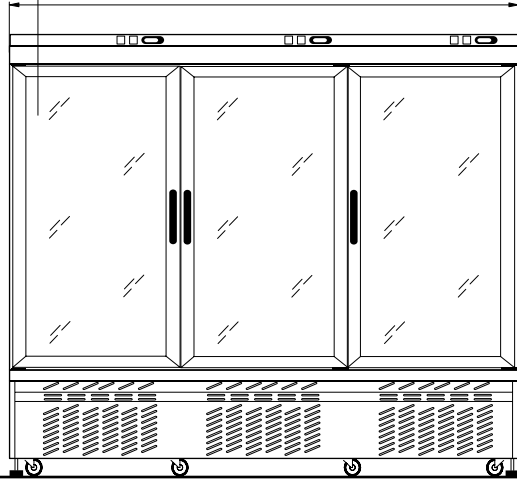

M XL

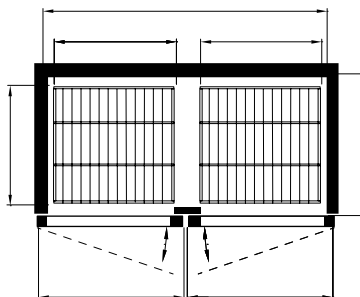
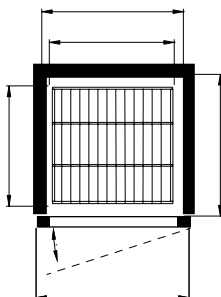
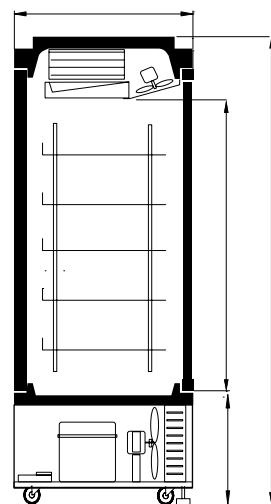
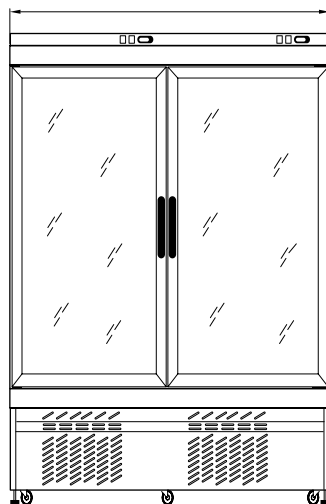
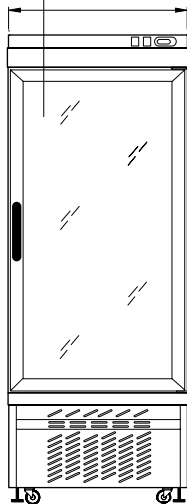

VERSIONE TOP

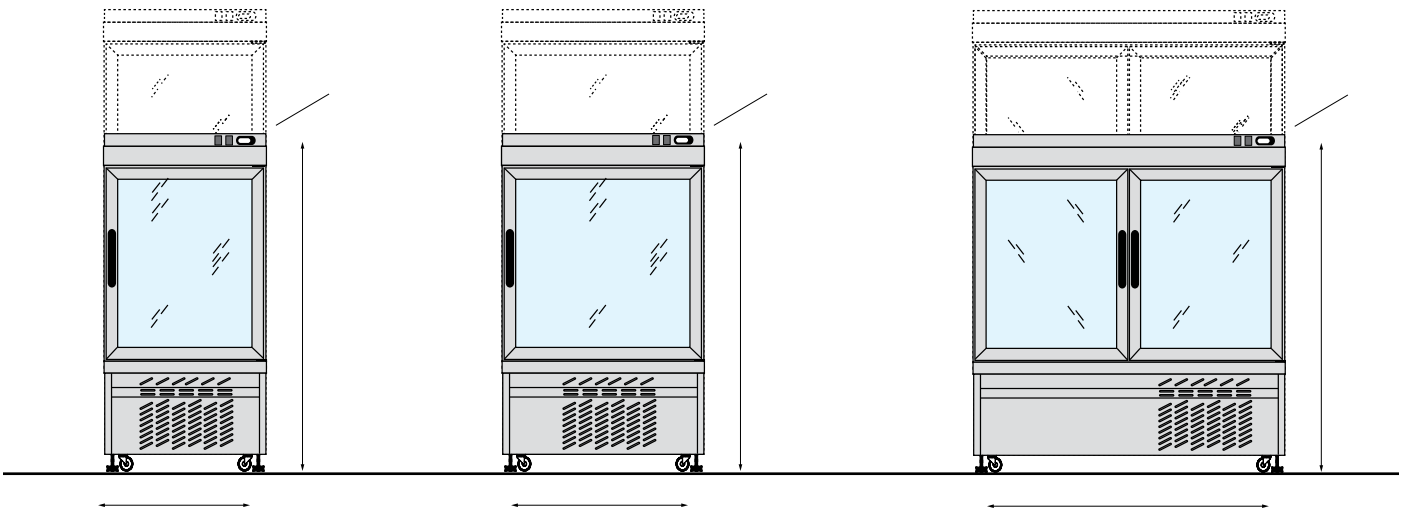

- **TUTTI I MODELLI STATICI E NO-FROST SONO DISPONIBILI NELLA VERSIONE "TOP"**
ALL OUR STASTIC AND NO-FROST MODELS ARE AVAILABLE IN THE "TOP" VERSION
- **15 % SCONTO APPLICABILE SUL MODELLO BASE SCELTO DAL LISTINO**
PRICE REDUCTION TO BE CALCULATED FROM THE PRICE OF THE CHOSEN MODEL



KOA-1

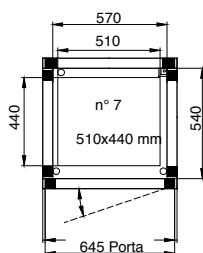
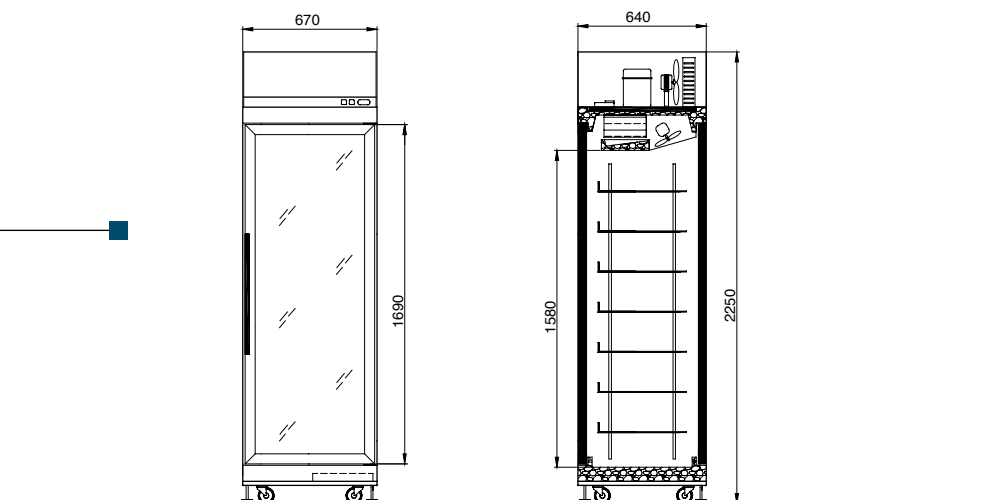

KOA-2

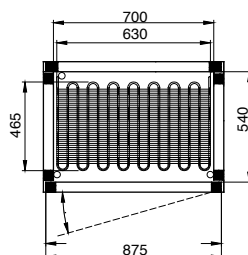
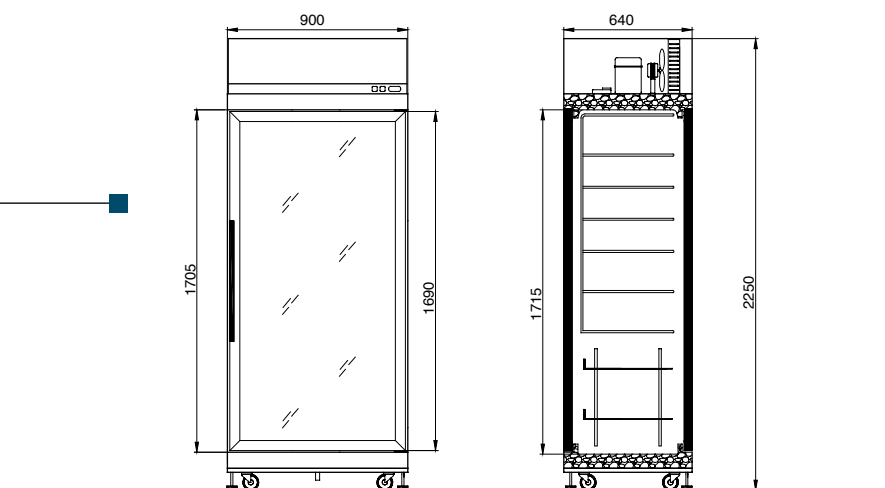

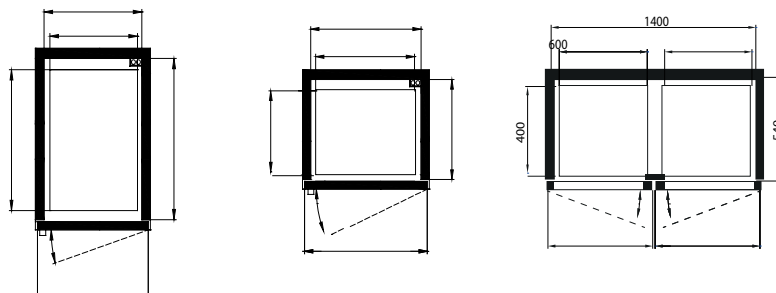
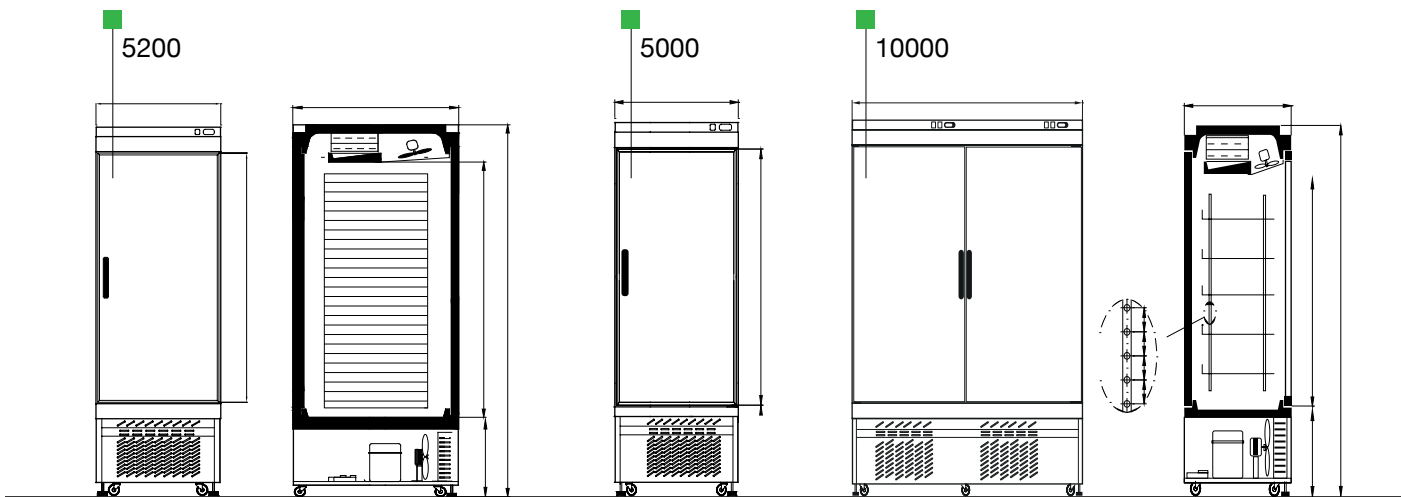
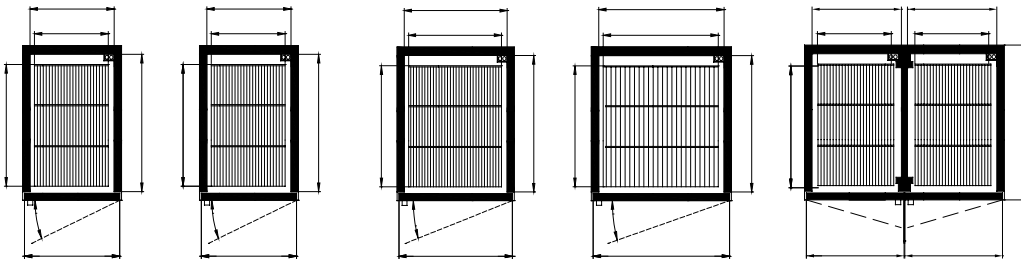
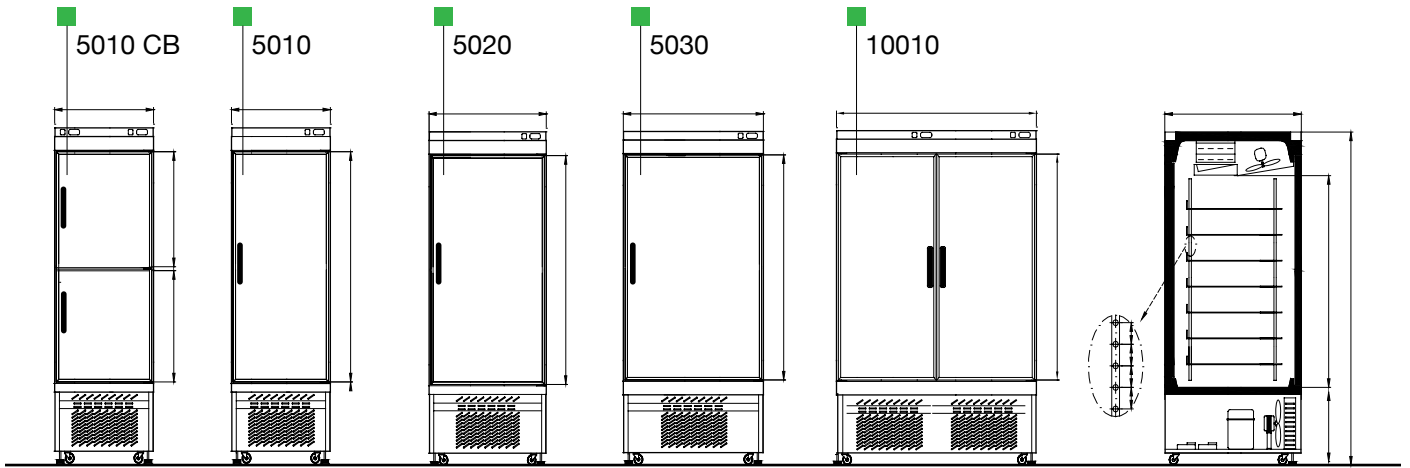

5010 HI

5010 HI-CB

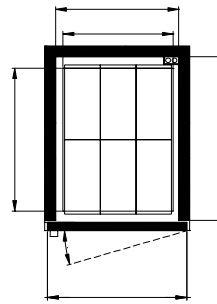
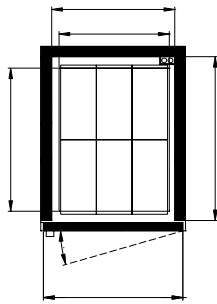
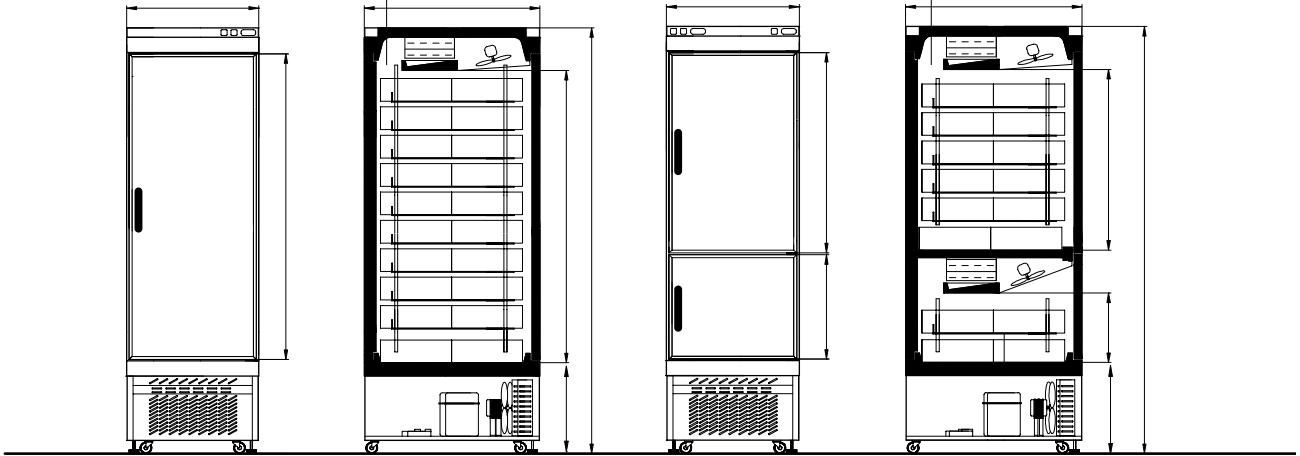

0040

0050

0090

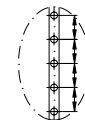
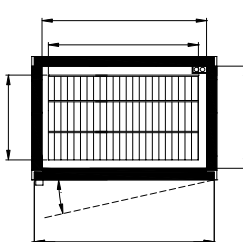
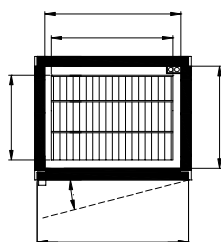
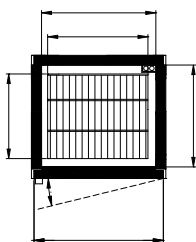
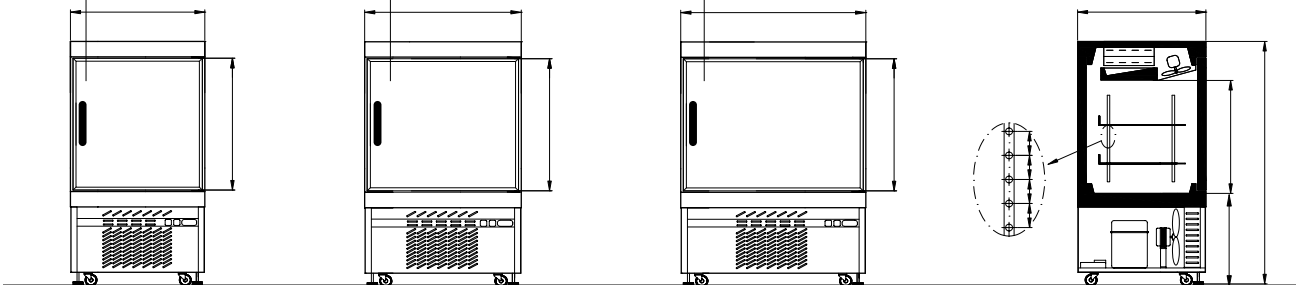

PANE-1

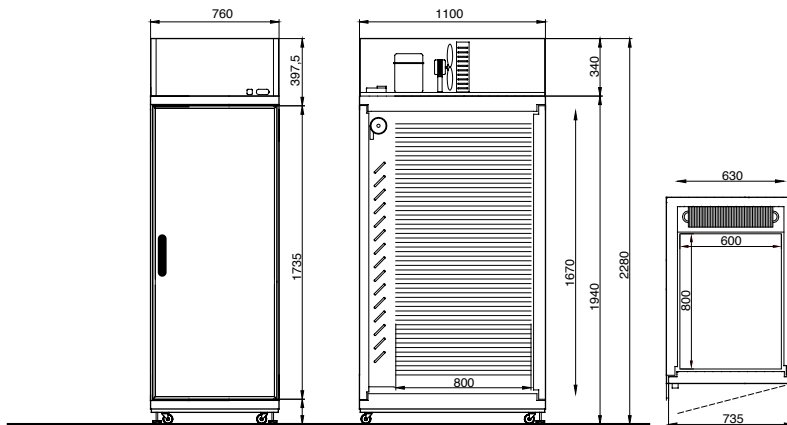

PANE-2

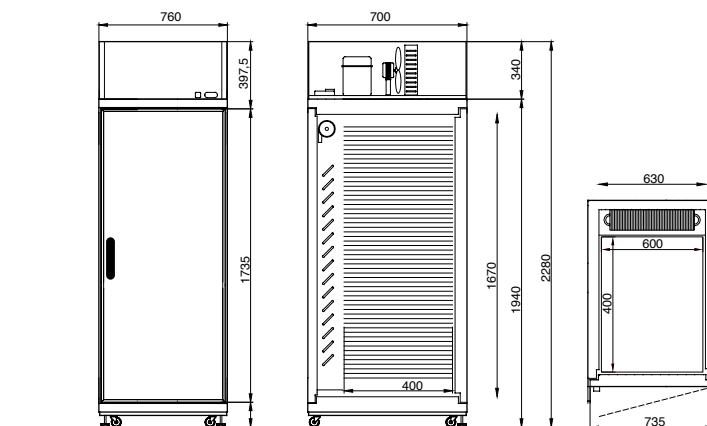

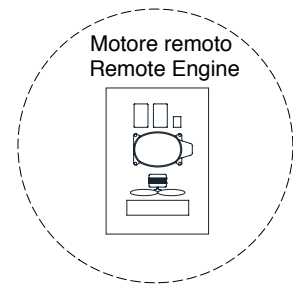
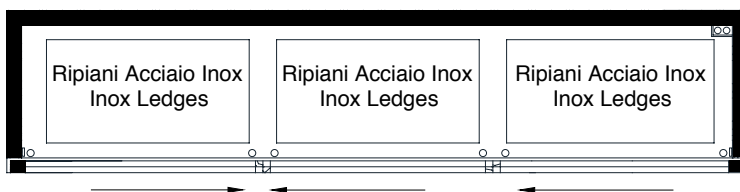
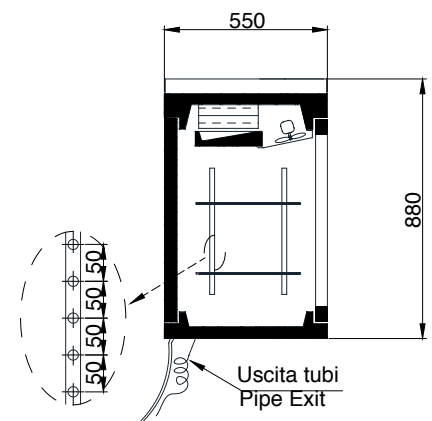
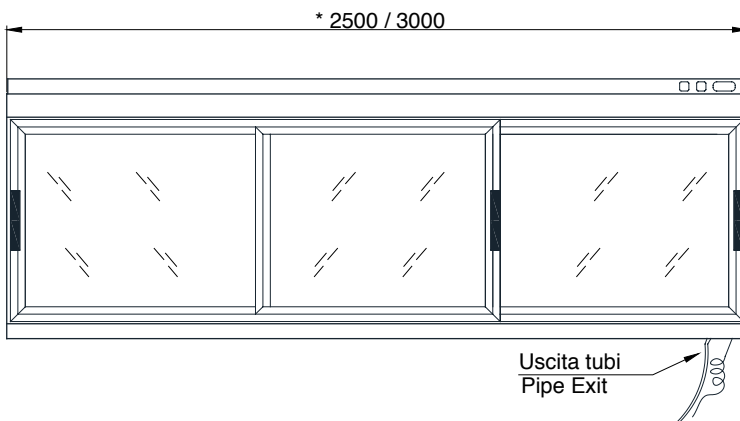
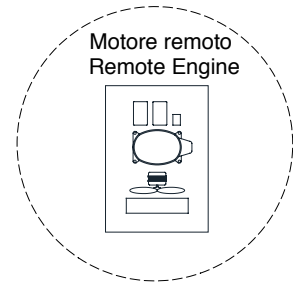
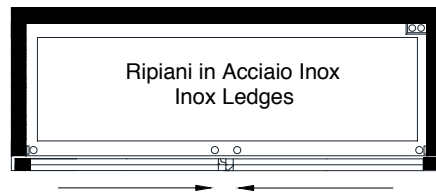
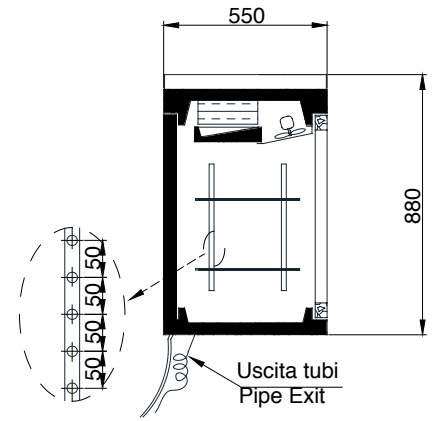
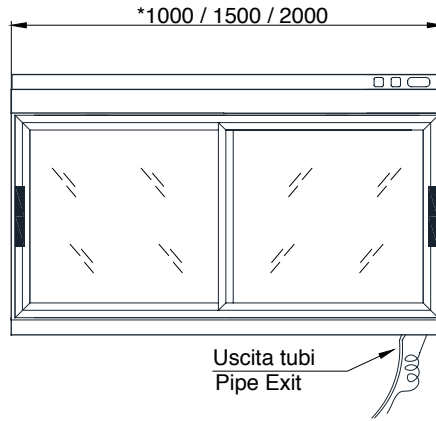

Tekna s.r.l. si riserva il diritto di apportare modifiche ai prodotti illustrati in questo catalogo, in qualunque momento senza l'obbligo di preavviso.

Tekna s.r.l. reserves the right to make modifications to the products shown in this catalogue at any time without prior notice.

Le foto riprodotte in questo catalogo sono indicative per le inevitabili differenze dovute alla riproduzione tipografica. I prezzi indicati si intendono con le finiture argento anodizzato o bronzo.

The pictures shown in the catalogue are approximate, as a printed reproduction causes inevitable colour differences. The prices refer to anodized silver or bronze finish.

- **I prodotti TEKNA sono costruiti in accordo con la Normativa Europea EN441 - 1991E**
 - TEKNA products are projected and manufactured according to the EC Norm EN 441 - 1991E
- **I gas refrigeranti utilizzati sono conformi alle normative internazionali vigenti**
 - The refrigerating gasses used are in accordance with the international normatives
- **I modelli sono dotati di gas refrigerante R452**
 - Models are endowed with refrigerant gas R452
- **Umidità relativa interna: 55/60 %**
 - Inside relative Humidity: 55/60 %
- **Sbrinamento automatico; per i modelli di tipo NT, sbrinamento manuale**
 - Automatic defrosting; for the models type NT, manual defrosting
- **Il costruttore si riserva il diritto di apportare modifiche di materiale e di modelli senza preavviso**
 - We reserve the right to make changes either in the materials used or the models without notice
- **I pesi, le misure, ecc., sono semplicemente forniti a titolo indicativo e non impegnano il costruttore**
 - Weights, dimensions, etc., are given purely as an indication and they do not engage the manufacturer
- **I dati tecnici sono teorici e riguardano condizioni di temperatura ambiente +30°C con umidità relativa di 65% UR**
 - Technical data are theoretical regarding a room temperature of 30°C with a relative humidity of 65% UR
- **Per le condizioni di garanzia vedasi "Manuale di istruzioni"**
 - For warranty see "Instruction hand book"
- **Foro competente: tribunale Varese**
 - Jurisdiction : court varese

RESA :
DELIVERY TERMS:

franco ns. stabilimento
ex-factory

IMBALLO STANDARD :
STANDARD PACKING :

compreso nel prezzo
included in the price

